

# **PSP20 Pool Pump Automatic Shut Off Instruction Manual**

**Approved Device by the CPSC for Secondary  
Protection against Entrapment**

**Tested to ASME A112.19.17**

**H2flow Controls Inc.  
3545 Silica Rd  
Sylvania OH 43560**

## **Virginia Graeme Baker Pool & Spa Safety Act:**

The Act requires, in single main suction drain installations, public pools and spas must have additional secondary devices or systems designed to prevent suction entrapment. Compliant "Secondary Devices" include an automatic shut-off device, gravity drainage system, Safety Vacuum Release System (SVRS), suction-limiting vent system. (IV) AUTOMATIC PUMP SHUT-OFF SYSTEM - An automatic pump shut-off system. An automatic pump shut-off system would be a device that could sense a drain blockage and shut off the pump system.

## **Guidelines:**

Guidelines have been produced by the National Pool and Spa Institute, the National Swimming Pool Foundation and the US Consumer Products Safety Commission to identify and address potential entrapment hazards in swimming pools, spa's and hot tubs. These guidelines include design standards and equipment that should be incorporated into every swimming pool, spa and hot tub. H2flow Inc. strongly recommend that these guidelines be reviewed and acted upon.

## **Warnings:**

The H2flow Inc. PSP20 is an Automatic Pump Shut Off device, which is recognized by the CPSC as an approved VGBA secondary protection method. The PSP20 has been applied with hydrostatic relief valves left in place. These devices had no detrimental affect on the operation of the PSP20, no nuisance shutdowns occurred, and on all entrapment tests the PSP20 shut down the pump within the time criteria specified by the ASME standard.

Secondary entrapment detection devices such as the H2flow Inc. PSP20 are intended to detect a drain suction blockage. These devices are not intended to detect hair or other partial blockages. To be compliant with the Virginia Graeme Baker Act an ASTM approved drain cover must be installed to prevent hair, clothing or physical entrapment.

The H2flow Inc. PSP20 is not designed to prevent evisceration type injuries.

The PSP20 is designed to be used as part of a "layers of protection" solution. All ASTM recommendations and limitations should be utilized with respect to this device.

When the PSP20 is in the 180 Second 'Prime' mode no protection for entrapment can be given. During this time it is imperative for swimmer's safety that no swimmers be allowed to enter the swimming pool.

When carrying out the PSP20 Autaset procedure to establish the trip characteristics of the unit, it is essential that the pump is in a normal running mode with the pump fully primed and all suction valves and discharge valves in their normal operating position.

Ensure that on completion of installation, the "Test Procedure" described in this manual is carried out to prove operation prior to swimmers being allowed to enter the pool.

**It is the User's responsibility to ensure that all aspects of the Virginia Graeme Baker Act are complied with.**

## Overview

The H2flow Inc. PSP20 is a protection device that is installed into the electrical connections of the pump motor to monitor the output power of the motor required to turn the pump. In the event of a blocked suction occurring, the PSP20 detects the change in motor power from the normal load and disconnects the supply from the motor. To correctly set the PSP20 so that deviations from the normal pump conditions can be detected, a simple push of the Autoset button (for 3 seconds) when the pump is running normally is all that is required.

On starting the pump following filter replacement or a drained pool it will be necessary for the pump to prime. To ensure that a nuisance alarm does not occur due to an un-primed pump, it may be necessary for the user to temporarily extend the time set in parameter 31 of this Manual.

**During this extended time period, the pool pump protection is disabled and swimmers should not be permitted into the pool. This Setting should be returned to its initial value after the pump has primed.**

During filter maintenance (Back Washing) the pump motor power will increase. This increase in power will be due to the pump now pumping against little or no restriction. There is no requirement for changes to be made to any set parameters or to isolate the PSP20 during these times. The PSP20 is protecting against a decrease in load which occurs when the suction to the pump is blocked.

The PSP20 should be tested at the time of filter back washing by carrying out the test procedure described later in this manual to ensure the correct operation and programming of the H2flow Inc. PSP20. Testing consists of closing the pump suction valve causing the pump to dry run. The PSP20 should shut the pump down within 1 second.

## Important Note

Except for any warranties or other express undertakings by H2flow Inc. pursuant to its Standard Terms and Conditions, H2flow Inc. assumes no responsibility for, and Buyer releases and holds H2flow Inc. harmless from, any liability of any kind whatsoever in connection with the equipment. Any equipment must be installed (i) by a qualified technician within the trade required for installation, (ii) in all respects in compliance with H2flow Inc.'s written installation instructions and manual attached hereto (the "Manual"), and (iii) without modification of any kind to the equipment or to the Manual. Buyer will operate the equipment (i) under normal conditions specified for it in the Manual, (ii) for the purpose, and within the operating limits for which it is designed and specified as set forth in the Manual, and (iii) without misuse, abuse or neglect. Buyer shall properly and timely conduct all maintenance, testing and inspections of the equipment recommended in the Manual, and all safety mechanisms and devices shall be in place and in operation at all times, without modification.

Equipment must be installed (i) by a qualified technician within the trade required for installation, (ii) in compliance with the manufacturer's and/or distributors instructions and/or installation manual, and (iii) without modification of any kind to the equipment or to the installation instructions and/or protocol. Buyer will operate the equipment (i) under normal conditions specified for it, (ii) for the purpose and within the operating limits for which it is designed and specified, and (iii) without misuse, abuse or neglect. Buyer shall properly and timely conduct all maintenance, testing and inspections of the equipment recommended in the instructions, and all safety mechanisms and devices shall be in place and in operation at all times, without modification.

## Inside The Box

Please check the delivery. Despite the fact that all products from H2flow Inc. are carefully inspected and packed, transport damage may occur:

Your shipment should contain the H2flow Inc. PSP20 Pool Pump Monitor and this manual

Check carefully that the equipment ordered complies with the motor's input voltage

Check the contents have not been damaged during shipping

If something is missing or has been damaged, contact H2flow Inc. Inc. within 48 hours of receipt.

**Note: If in doubt, contact H2flow Inc. Inc. before installing the equipment.**

## Safety

Study this manual thoroughly before installing and using the PSP20

The PSP20 should be installed by qualified personal

Always disconnect supply circuits prior to installing

The installation must comply with applicable standards and local regulations

It is the user's responsibility to frequently check the operation of the installation. H2flow Inc. will not accept any responsibility for loss or damage relating to incorrectly installed or has not been frequently tested to prove operation

Pay special attention to the information in this chapter and the parts marked Caution in the operation and programming chapters

Check that the PSP20 and associated equipment are correctly connected before use

Should questions or uncertainties arise, please contact H2flow Inc. for assistance.

Damage that occurs due to incorrect installation or operation of this equipment are not covered by the manufacturer's warranty.

The installation and test instructions in this manual must be referred to during installation and testing of the equipment. This manual must be made available to the end user so that during routine testing the test procedure instructions can be referred to.

# PSP 20-10-xx Single Phase 120 Vac

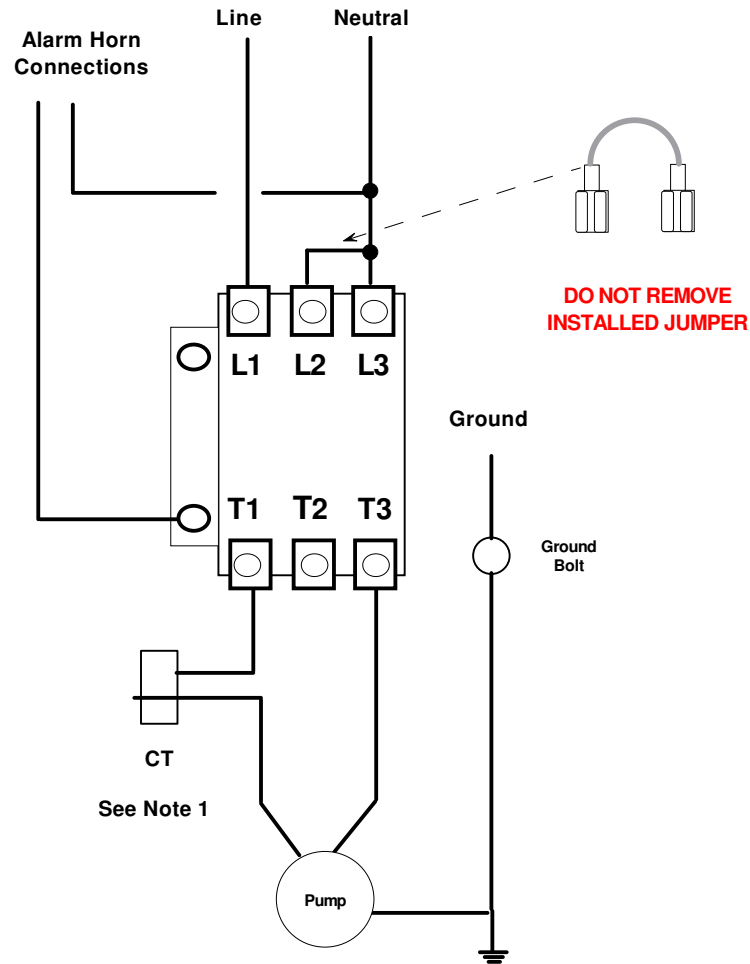
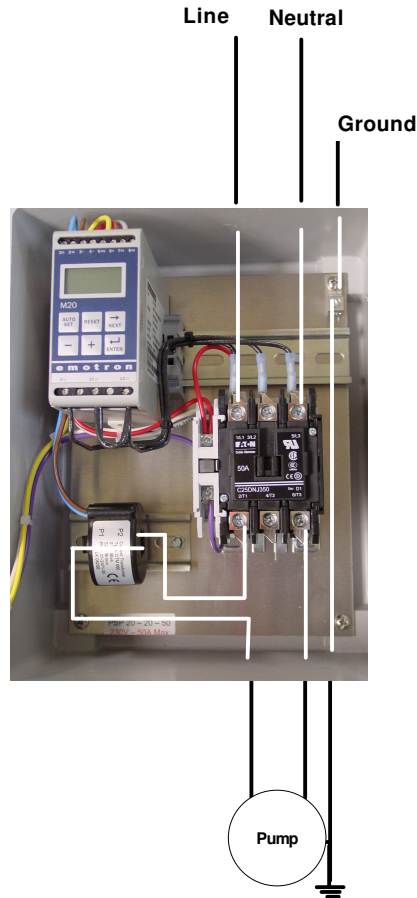

## Model PSP 20-10- 25

Motor HP	CT Windings
	120 Vac
0.5	2
0.75	1
1.0	1
1.5	1

## Model PSP 20-10- 50

Motor HP	CT Windings
	120Vac
20	1
30	1

### Note 1

Review Tables and pass the motor lead on phase T1 through the center of the supplied Current Transformer (CTM) the number of times shown (Example below shows 2 windings)

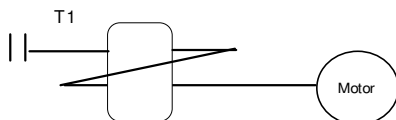

120Vac Single Phase

# PSP 20-20-xx Single Phase 208 - 240 Vac

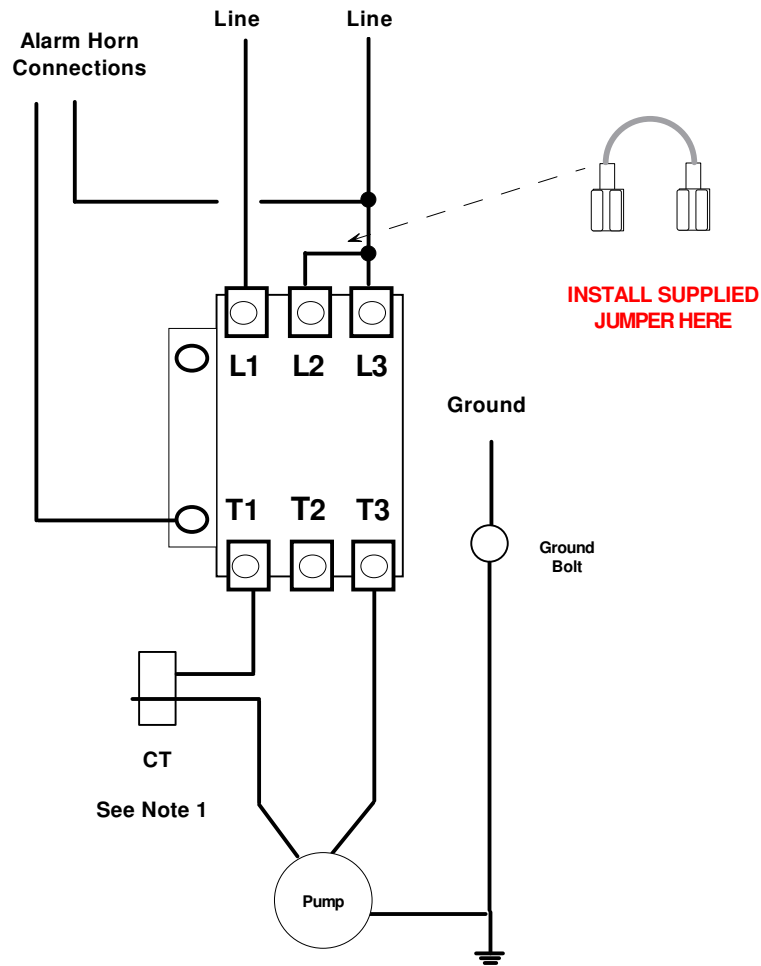
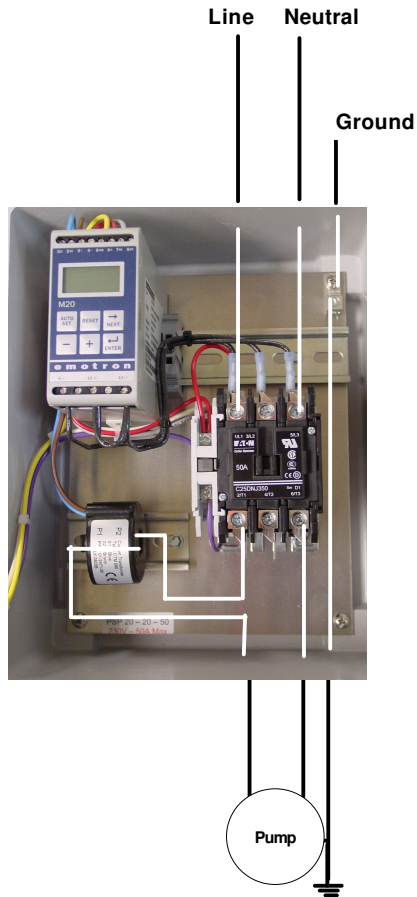

208/240Vac Single Phase

## Model PSP 20-20- 25

Motor HP	CTM Windings
	208/240 Vac
0.5	4
0.75	2
1.0	2
1.5	2
2.0	1
3.0	1

## Model PSP 20-20- 50

Motor HP	CT Windings
	208/240Vac
5.0	1
7.5	1

## Model PSP 20-20- 65

Motor HP	CT Windings
	208/240Vac
10.0	1

### Note 1

Review Tables and pass the motor lead on phase T1 through the center of the supplied Current Transformer (CTM) the number of times shown (Example below shows 2 windings)

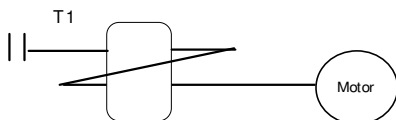

# PSP 20-20-xx Three Phase 208-240 Vac

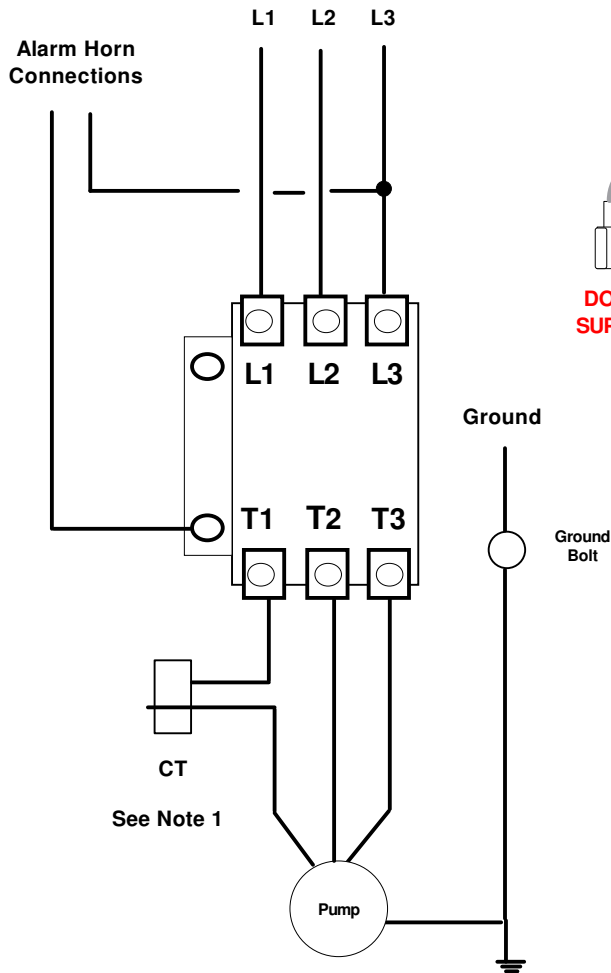
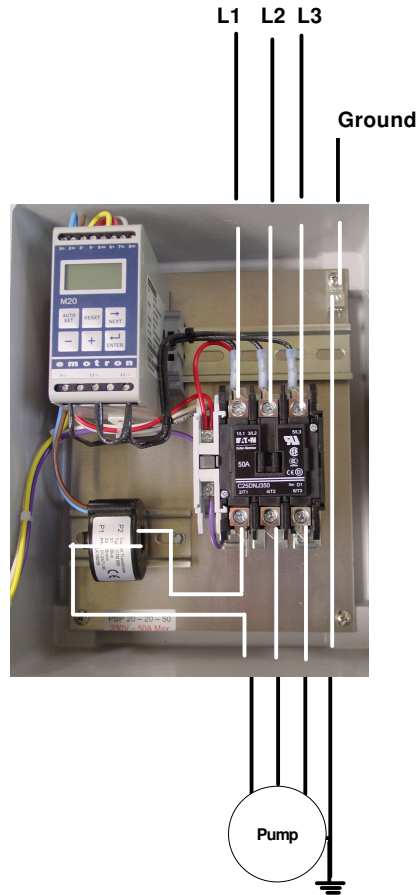

## Model PSP 20-20- 25

Motor HP	CT Windings
	208/240 Vac
0.5	6
0.75	4
1.0	4
1.5	2
2.0	2
3.0	2
5.0	1
7.5	1

## Model PSP 20-20- 50

Motor HP	CT Windings
	208/240Vac
10.0	1

## Model PSP 20-20- 65

Motor HP	CT Windings
	208/240Vac
15	1
20	1

## Model PSP 20-20- 100

Motor HP	CT Windings
	208/240Vac
25	1
30	1

### Note 1

Review Tables and pass the motor lead on phase T1 through the center of the supplied Current Transformer (CTM) the number of times shown (Example below shows 2 windings)

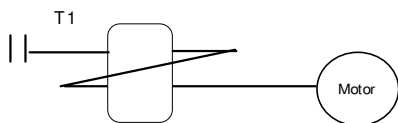

208/240Vac Three Phase

# PSP 20-40-xx Three Phase 480 Vac

Separate Source 120Vac Control Voltage Required

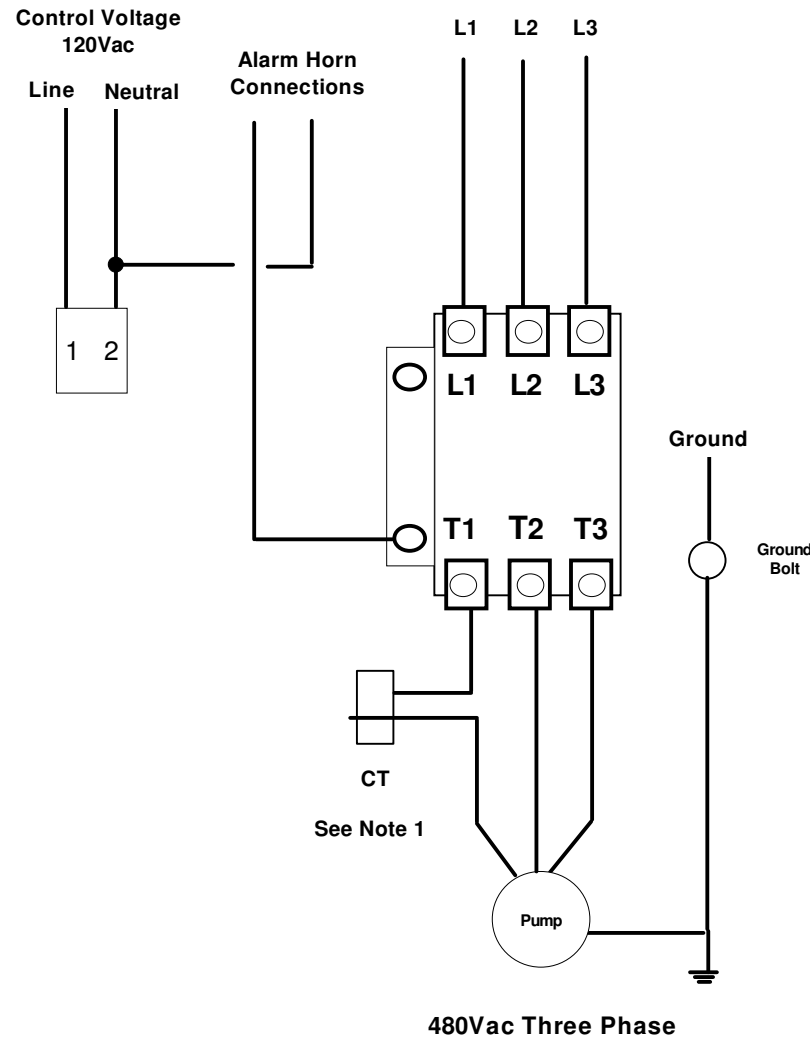
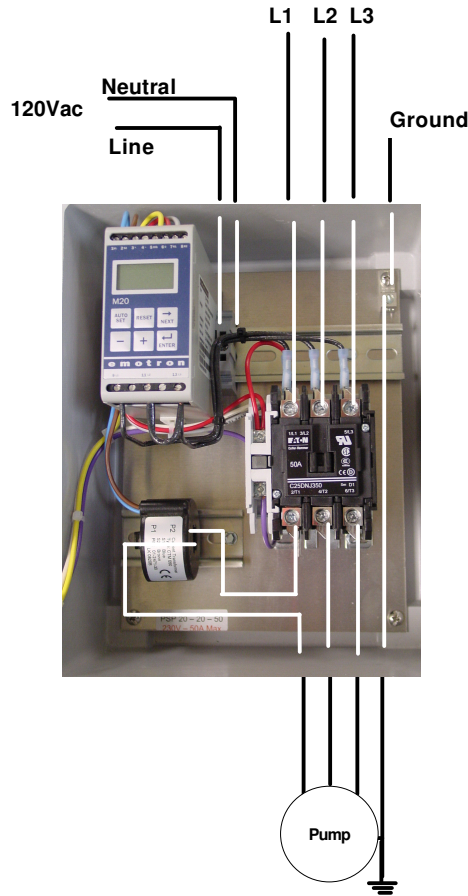

**Note 1**

Review Tables and pass the motor lead on phase T1 through the center of the supplied Current Transformer (CTM) the number of times shown (Example below shows 2 windings)

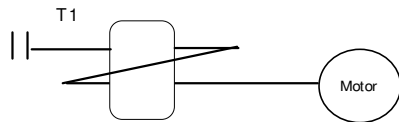

**Model PSP 20-40- 10**

Motor HP	CT Windings
	460 Vac
0.5	6
0.75	4
1.0	3
1.5	2
2.0	2
3.0	2
5.0	1
7.5	1

**Model PSP 20-40- 25**

Motor HP	CTM Windings
	460 Vac
10.0	1
15.0	1

**Model PSP 20-40- 50**

Motor HP	CT Windings
	460 Vac
20.0	1
25.0	1
30.0	1

**Model PSP 20-40- 65**

Motor HP	CT Windings
	460 Vac
40.0	1

**Model PSP 20-40- 100**

Motor HP	CT Windings
	460 Vac
50.0	1

# PSP 20-50-xx Three Phase 575 Vac

Separate Source 120Vac Control Voltage Required

### Model PSP 20-50- 10

Motor HP	CT Windings
	575 Vac
0.5	10
0.75	5
1.0	5
1.5	3
2.0	3
3.0	2
5.0	1
7.5	1

### Model PSP 20-50- 25

Motor HP	CTM Windings
	575 Vac
10.0	2
15.0	1
20.0	1

### Model PSP 20-50- 50

Motor HP	CT Windings
	575 Vac
25.0	1
30.0	1
40.0	1

### Model PSP 20-50- 65

Motor HP	CT Windings
	575 Vac
50.0	1

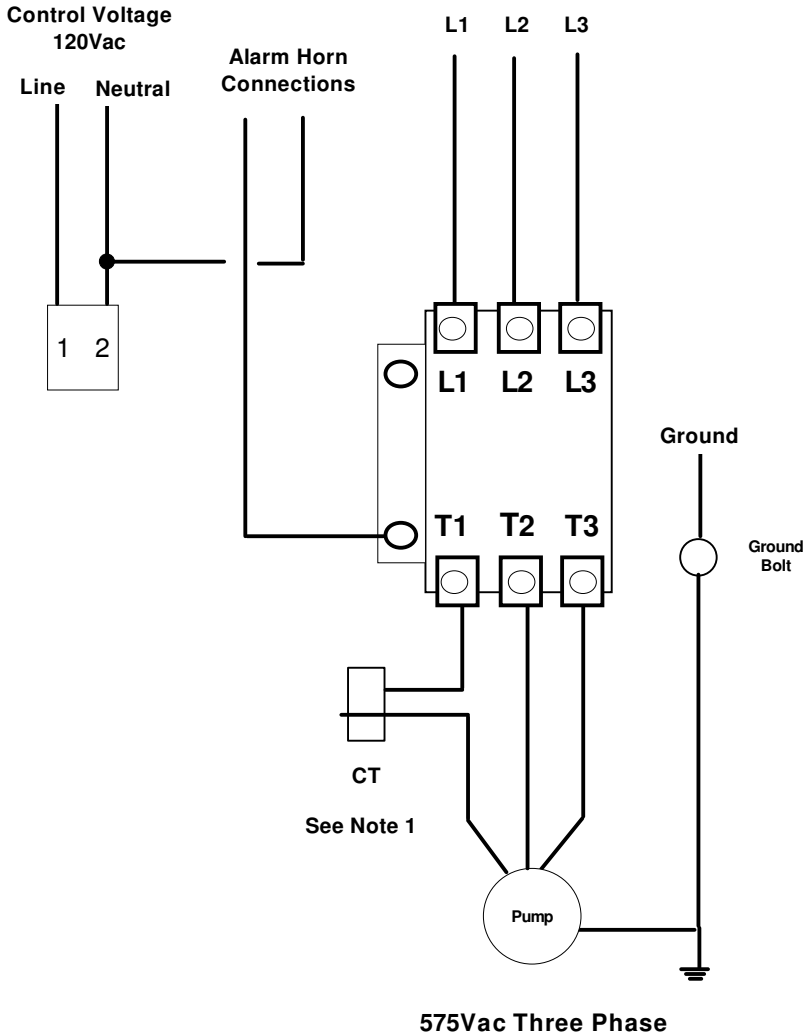
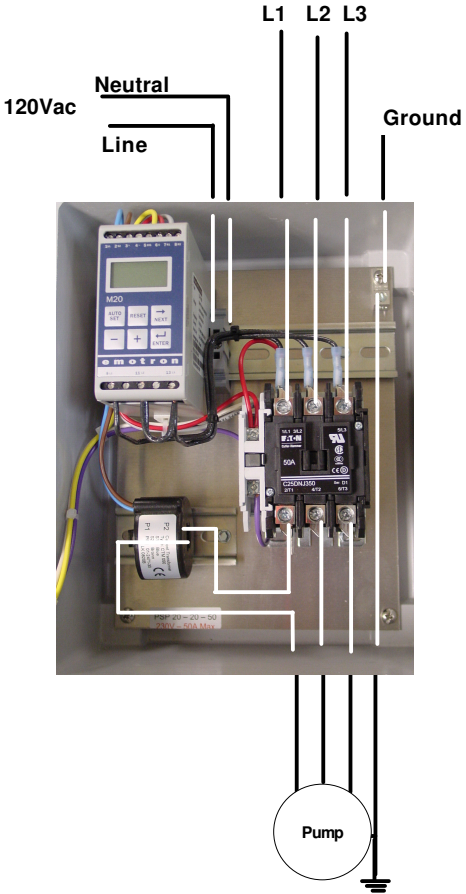

**Note 1**

Review Tables and pass the motor lead on phase T1 through the center of the supplied Current Transformer (CTM) the number of times shown (Example below shows 2 windings)

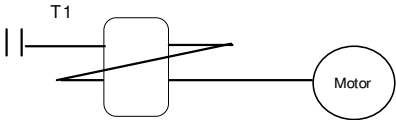

# Quick Start Guide

Check that the PSP20 installed is for the correct system voltage and correct motor current. H2flow Inc. will not be responsible for damage caused by installation of the PSP20 to a different voltage or higher current than it was supplied for.

Read and comply with the safety instructions printed at the front of this manual

**Caution:** In order to avoid personal injury, make sure that all safety measures have been taken before switching on the supply voltage and starting the pump motor

## Step 1 - Pump Startup

Apply Power to the PSP20 panel

The alarm lamp will light for approximately 2 seconds then it will turn off as the pump starts.

## Step 2 - Enter Motor Horse Power (Window 41)

Use **Next** to move to Window 41

For Accurate monitoring ensure the correct data is obtained from the motor nameplate

Display Window 41  Default Value 3 HP

Settings 0.13 - 999 HP

Press  or  until desired value reached

Press  to accept new value

## Step 3 - Enter Motor Full Load Amps (Window 42)

Use **Next** to move to Window 42

For Accurate monitoring ensure the correct data is obtained from the motor nameplate

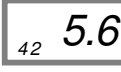
Display Window 42  Default Value 5.6 Amps

Settings 0.01 - 999 Amps

Press  or  until desired value reached

Press  to accept new value



## Step 4 - Enter Number of Phases (Window 43)

Use **Next** to move to Window 43

For Accurate monitoring ensure the correct data is obtained from the motor nameplate

Display Window 43  Default Value 3PH

Settings 1PH 3PH

Press  or  until desired Setting reached

Press  to accept new value



## Step 5 -

Use **Next** to move to Window 01

Display Window 01  **XX** is display % Motor Power

Window 01 will display the monitored motor % HP and a start timer

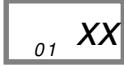
 **XX** is display % Motor Power

After a few Seconds Window 01 will display 'Shaft Power' as a % of the motor rated HP

At this time ensure that Window 01 Displays a value between 40% and 125%.

**NOTE:** If the value displayed is **oor** (Out of Range) then disconnect the power to the PSP20 panel and reduce the number of passes of wire that you passed through the current transformer during installation

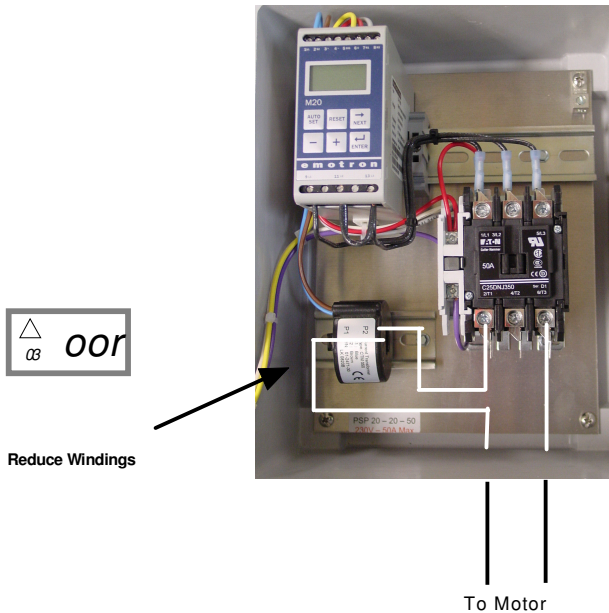

**NOTE:** If the value displayed is **oor** (Out of Range) and you only have **1 pass** of wire through the current transducer, return to window 41 and **increase** the value of motor HP until window 01 reads a % value between 40% and 125%

Use **Next** to move to Window 41

Display Window 41  Default Value 3 HP

Settings 0.13 - 999 HP

Press  or  until desired value reached

Press  to accept new value

**NOTE:** If the value displayed is less than 40%; Then disconnect the power to the PSP20 panel and increase the number of passes of wire that you passed through the current transformer during installation.

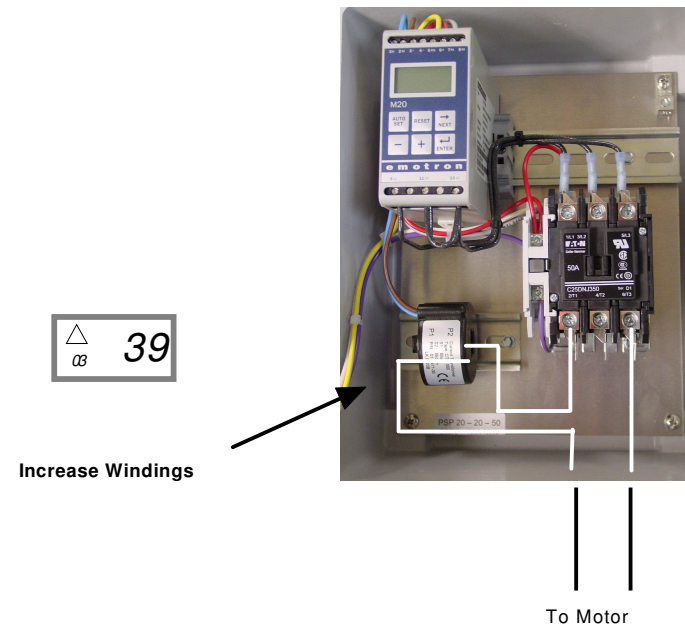

## Step 6 - Auto Set Protection Parameters

Ensure that the pump is primed and running normally before completing the following step

To Set the PSP20 to give protection for a blocked suction condition press and hold the Autoset Button for 3 seconds after the start timer has disappeared from the display



Display Window 01  XX is display % Motor Power



Hold  for 3 seconds until Window 01 displays SET



## Step 7 - Spa's and Hot Tubs Only

Spa's and hot tubs which have pumps that do not lose their prime, will not require the 180 Second delay programmed for 'Prime'. To reduce this time:

Use  to move to Window 31 

Press  until Window 31 displays 2.0 

Press  to accept new value

For Assistance Call H2flow Inc. and ask for Technical Support 419 841 7774

## Step 8

# Test Procedure

The following Procedure will test the installation of the PSP20 and will shut down the pump providing the installation has been completed correctly. This procedure should be repeated every time the filters are back washed or every 7 days to ensure that if a blocked suction condition arises the pump will automatically shut down.

**On Pool applications with skimmer's, close the skimmer valves prior to completing this procedure**

**Ensure that the pump is running**

**Ensure that the Timer has disappeared from The Display**

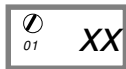
Timer →  Wait - Do Not Proceed

No Timer  Proceed

To test the PSP20 for a blocked suction condition, ensure that the LCD display shows window 01

Display Window 01 

Close the pump suction valve. Within 1.0 Second the pump should shut down

The display will show Function Underload 

The panel Reset push button Light will be illuminated, showing a blocked suction condition has occurred



To reset the alarm and to restart the pump, press either the  or the remote Reset Push Button located on the door of the PSP20

**Customer to carryout this procedure frequently. A recommended frequency would be at the time of filter backwash or every 7 days**

## Step 9 - Lock Keyboard From Changes (Window 4)

Use **Next** to move to Window 04

To prevent unauthorized tampering with the parameters

Display Window 04 

Hold **+** until Window 04 displays 369 

Press **ENTER** to accept new value 

Lock Symbol Displayed

Repeat to unlock (No Lock Symbol Displayed)

## Step 10 - Padlock Enclosure

To ensure there is no unauthorized access to the PSP20 enclosure and the H2flow Inc. PSP20 parameters please ensure that a padlock is fitted to the hasp of the PSP20 enclosure.



# Pool Vacuuming

Under certain circumstances when vacuuming the pool, if the circulation pump is not able to pull all of the water that it requires through the vacuum hose, the load on the pump will drop and depending upon the amount that it drops the PSP20 may cause the pump to shut down. If this is the case follow the procedures below.

## Step 1 - Partially Open Main Drain Valve

Partially open the main drain valve to the pump to allow the pump to pull the amount of water that it needs to maintain normal load. Doing this will prevent the pump from cavitating and premature failure.

In the event that partially opening the main drain valve does not allow effective vacuuming, please use the following procedure to more accurately set the entrapment shut off value, which will allow for vacuuming without the pump shutting down.

## Step 2 - UnLock Keyboard (Window 4)

Use **Next** to move to Window 04

Display Window 04 

Hold **+** until Window 04 displays 369 

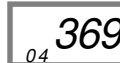
Press **ENTER** to accept new value 

## Step 3 - Shut Down Pool Pump

Shut down the pump using the pump's circuit breaker.

## Step 4 - Re-Start Pool Pump

Restart the pump using the pump's circuit breaker.

## Step 5 - Determine Entrapment Level (Window 01)

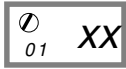

XX is display % Motor Power

While clock shows in top left of the LCD display

Record the value shown for % Motor Power

 %

Shut the skimmer and the main drain valves

Record the new value for % Motor Power

 %

Open the skimmer and the main drain Valves

Subtract Value 2 from Value 1

 %

Subtract 5 from Value 3

 % - 5 =  %

## Step 6 - Setting new entrapment level into PSP20 (Window 24)

Press  to move to Window 24

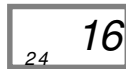

Press  until Window 24 is set to value 4 calculated above

Press  to accept new value

Hold  for 3 seconds until SEt is displayed



## Step 7 - Test New Value

Follow Test Procedure on next page

## Step 8 - Lock Keyboard (Window 4)

Repeat Step 2 on this page to re-lock the keyboard

# Alarm Messages (Window 00)

## Main Alarm (Overload) Exceeded



Will only occur if Parameter 5 is incorrectly set

The Main Alarm level set in Window 11 has been exceeded

Relay R1 has changed state

Press  to reset the alarm once the load has dropped below the set value

**NOTE** If Parameter 61 is set to OFF the Alarm will automatically reset when the load drops below the set value

## Pre Alarm(Overload) Exceeded



Will only occur if Parameter 5 is incorrectly set

The Pre-Alarm level set in Window 12 has been exceeded

Relay R2 has changed state

The Pre-alarm automatically resets once the load has dropped below the set value

## Main Alarm (Underload)

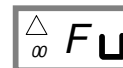

The measured load has fallen below the Main Alarm Level set in Window 14

Relay R1 has changed state

Press  to reset the alarm once the load has dropped below the set value

**NOTE** If Parameter 61 is set to OFF the Alarm will automatically reset when the load drops below the set value

# Troubleshooting Guide

## Pre Alarm (Underload)



The load level has fallen below the Pre-Alarm Level set in Window 13

Relay R2 has changed state

The Pre-alarm automatically resets once the load has risen above the set value

## Alarm at No Motor Current

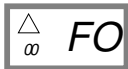

Will only occur if Parameter 62 is incorrectly set

Parameter 62 (No Motor Current) is set to 'on'

## Supply Voltage

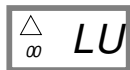

The voltage measured at terminals 9, 11 and 13 is below the range of the PSP20

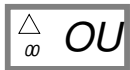





The voltage measured at terminals 9, 11 and 13 is above the range of the PSP20

Turn off the supply to the PSP20 to prevent damage

Review the Voltage requirements on the PSP20 label

Problem	Solution
Window 01 always shows zero load even when the motor is running	Ensure that the CT is in the L1 phase going to the motor , not in the wire that is connected to L1 feeding the PSP20 module. Check that the CT is in the same phase as the phase connected to Terminal 9. Check the current transformer is connected to terminals 1 and 2 and good contact is being made. Check that window 03 shows a phase current. Ensure that the value set in window 41 is the same as the rated motor power. Check that the value in window 42 is the same as the motor FLA amps.
Window 01 shows an improper power reading when the motor is running	Check that the CT is in the same phase as the phase connected to Terminal 9. Check the correct CT has been used for the size of the motor FLA. Check the number of loops through the CT is correct
Window 03 shows an improper value of the phase current	Check that the CT is in the same phase as the phase connected to Terminal 9. Check the correct CT has been used for the size of the motor FLA. Check the number of loops through the CT is correct  Check that the value in window 42 is the same as the motor FLA amps.
The monitor does not shut the motor down on 'Test'	Check that window 01 shows a value greater than zero with the motor running. Raise the alarm parameters in window 14 to be above the normal running load and ensure that display 00 shows Underload. If the PSP20 responds correctly re-evaluate the alarm levels required.
The monitor is continually in alarm	Review the alarm parameter in window 14 and ensure that the value is less than the normal reading (when the motor is running) in window 01  Check to see if Window 61 (alarm latch) is set to ON. If so a reset is required.
Message displayed is either LU or OU	See Alarm Messages other Windows
Window 01 Message displayed is oor	See Alarm Messages other Windows
Window 03 Message displayed is oor	See Alarm Messages other Windows

## Parameter List

Window	Function	Range	Symbol	Default	Presets
00	Alarm Indication				
01	Shaft Power	0 - 125% KW 0 - 745 KW 0 - 125 % HP 0 - 999 HP	% KW %	0 - 125 % KW	%HP
02	Actual Line Voltage	90 - 760 Vac	V		
03	Measured Current	0.00 - 999A	A		
04	Parameter Lock	0 - 999			
05	Monitor Function	Overload Underload Overload & Underload	  	Overload & Underload	Underload
11	Max Main Alarm (Relay 1)	0 - 125 0 - 745 0 - 125 0 - 999	% KW %	100 2.2 100 3	
12	Max Pre-Alarm (Relay 2)	0 - 125 0 - 745 0 - 125 0 - 999	% KW %	100 2.2 100 3	
13	Min Pre-Alarm (relay 2)	0 - 125 0 - 745 0 - 125 0 - 999	% KW %	0 0 0 0	
14	Min Main Alarm (Relay 1)	0 - 125 0 - 745 0 - 125 0 - 999	% KW %	0 0 0 0	
21	Max Main Alarm margin	0 - 100	%	16	
22	Max Pre-Alarm margin	0 - 100	%	8	
23	Min Pre-Alarm margin	0 - 100	%	8	
24	Min Main Alarm margin	0 - 100	%	16	
31	Start Delay	1 - 999	S	2.0	180.0
32	Response Delay Max	0.1 - 90	S	0.5	
33	Hysterisis	0 - 50	%	0	
34	Response Delay Min	0.1 - 90	S	0.5	1.0
35	Pause/Reverse Time	3-90	S	5	

Window	Function	Range	Symbol	Default	Presets
36	Auto Reset	0-5	0		
41	Rated Motor Power	0.10 - 745 0.13 - 999			Customer To Set
42	Rated Motor FLA	0.01 - 999			Customer To Set
43	Number of Phases	1PH / 3PH			Customer To Set
61	Main Alarm Latch	on/OFF		OFF	ON
62	Alarm At No Motor Current	on/OFF		OFF	
63	Main Alarm Relay 1	nc/no		nc	nc
64	Pre-Alarm Relay 2	nc/no		nc	
65	Relay Function	M20/DLM/Rev		0	
81	Digital Input	rES / AU / bLo		rES	
82	Block Timer	0.0 - 90	S	0.0	
91	Analog Output	0.20 4.20 20.0 20.4	0.20	0.20	
92*	Analog Output Low	0 - 100			
93*	Analog Output High	0 - 125			
99	Factory Defaults	dEF / USr		dEF	

Grayed out parameters are not required for this application.