



OWNER'S MANUAL

1-2 PERSON AND 2-PERSON HEMLOCK SAUNA



Please do not hesitate to contact our consumer hotline at 1-800-759-0977 with any questions that may arise during assembly or use of this product.



TABLE OF CONTENTS

ASSEMBLY TIPS & WARNINGS	3
HEALTH & SAFETY WARNINGS	4
PARTS IDENTIFIER	5
REPLACEMENT PARTS	5, 6, 8
PARTS SCHEMATIC	7, 9
SAUNA ASSEMBLY INSTRUCTIONS	10-14
DIGITAL CONTROL INSTRUCTIONS	15
COLOR THERAPY LIGHT INSTRUCTIONS	15
MP3 PLAYER INSTRUCTIONS	16
TROUBLESHOOTING GUIDE	17-18
SAUNA USE DISCLAIMER	18
ENJOYING YOUR SAUNA	19
CLEANING & MAINTENANCE	19
WARRANTY	20-21

NOTE: The information contained in this manual is subject to change without notice.

ASSEMBLY TIPS & WARNINGS

- Before you begin, read all assembly instructions and safety warnings carefully.
- This sauna requires at least 2 adults to complete assembly.



- Remove all of the contents from the boxes and verify that you have all of the parts shown on the Parts Identifier (Page 5) before you begin assembly. *Note: Some parts may be pre-installed or pre-assembled.*
- This manual is used for the assembly of several sauna models; therefore, some figures or drawings may not look exactly like your product.
- Cover the sauna floor during assembly to avoid staining the unfinished wood surface.
- Retain this owner's manual for future reference.

ELECTRICAL REQUIREMENTS:

- We recommend consulting a licensed electrician and checking local ordinances before installing ANY sauna.
- These saunas require a 15 amp receptacle. **Note: Electrical modifications may be required to accommodate 15 amp power.**
- Refer to the serial plate on the back of the sauna for complete electrical specifications.
- **These saunas require a dedicated circuit - no other appliances should share the same outlet with the sauna.**



FIRE WARNING: If your sauna is not properly installed by an electrician, it may cause a house fire.

























CHOOSING A LOCATION:

- This sauna should only be placed INDOORS on a dry, level surface.
- There should be a minimum of 5 inches clearance between the sauna and any wall.
- Make sure the main power cord will reach the outlet and remain easy to access.
- The sauna should only be used in a dry location as moisture will damage the wood and electrical components.
- Keep the sauna away from any potential hazards including water sources, flammable objects, and combustible materials.

HEALTH & SAFETY WARNINGS

1. Review all instructions and warnings before operating your sauna. A sauna is not a toy. Serious injury may result from negligence, intentional misuse, and failure to follow safety instructions.
2. Hyperthermia Danger: Hyperthermia occurs when the body absorbs more heat than it can dissipate. Hyperthermia is a medical emergency and requires immediate treatment to prevent disability or death. It is very important not to allow your body's core temperature to rise above 103°F. Symptoms of hyperthermia include dizziness, lethargy, drowsiness, and fainting. The effects of hyperthermia may include failure to perceive heat, failure to recognize the need to exit the sauna, unawareness of the impending health hazard, physical inability to exit the sauna, and unconsciousness.
3. If you are feeling uncomfortable, faint, or dizzy - exit the sauna immediately.
4. Do not exceed recommended time and temperature guidelines.
5. Do not touch or interfere with the temperature sensor on the control panel.
6. Do not touch or spray water on the heater elements.
7. Do not use the sauna while under the influence of drugs or alcohol.
8. Do not sleep inside the sauna.
9. Do not use the sauna immediately following strenuous exercise. Allow your body to cool down for 30 minutes before entering the sauna.
10. Pets should never be placed inside the sauna.
11. Pregnant women, children under the age of 6, the elderly, and the infirm should not use the sauna.
12. Children over the age of 6 should always be supervised by an adult.
13. People with health problems including open wounds, fever, sunburn, or dehydration should not use the sauna.
14. People suffering from obesity or with a history of heart disease, low or high blood pressure, circulatory system problems, or diabetes should consult a physician before using the sauna.
15. Consult a physician before using the sauna if you take any prescription medications.
16. Keep towels and combustible materials away from the heater elements.
17. Remove all towels and materials after your sauna session.
18. Never leave your sauna unattended while in use.
19. Always unplug the sauna and allow it to cool down before performing any cleaning or maintenance.
20. Always turn off and unplug the sauna when not in use.

PARTS IDENTIFIER (NOT TO SCALE)

 FRONT PANEL WITH GLASS DOOR	 LEFT PANEL	 RIGHT PANEL	 BACK PANEL	 ROOF
 ROOF COVER	 FLOOR	 FLOOR HEATER	 BENCH SEAT	 BENCH HEATER PANEL
 BACK PANEL HEATER COVER	 BACKREST	 DOOR HANDLE	 COLOR THERAPY CONTROL PANEL	 OXYGEN IONIZER
 CUP HOLDER	 MAGAZINE RACK	 DOUBLE TOWEL HOOK	 MP3 PLAYER	
 2" (50mm) SCREW	 1-1/2" (40mm) SCREW	 1-1/8" (30mm) SCREW	 3/4" (20mm) SCREW	
ADDITIONAL EQUIPMENT REQUIRED:  PHILLIPS HEAD* SCREWDRIVER	 STEP LADDER*			

*Not included

REPLACEMENT PARTS

The following pages list part numbers specific to each sauna model. In the event that you need replacement parts, use this guide to reference the part number. It is important to use only replacement parts specified by the manufacturer. The use of unauthorized substitutes may damage your sauna or cause electrical hazards resulting in injury or fire, and will void the warranty. **For replacement parts, please call 1-800-759-0977.**

REPLACEMENT PARTS (CONT.)

SA3202 1-2 PERSON HEMLOCK MAJESTIC SAUNA WITH CARBON HEATERS

REF. #	DESCRIPTION	PART NUMBER	QTY.
1	FLOOR	SAP5006	1
2	BACK PANEL	SAP5002	1
3	LEFT PANEL	SAP5003	1
4	RIGHT PANEL	SAP5004	1
5	FRONT PANEL WITH GLASS DOOR	SAP5001	1
6	ROOF	SAP5005	1
7	ROOF COVER	SAP4608	1
8	BENCH HEATER PANEL	SAP4628	1
9	BENCH SEAT	SAP4436	1
10	330W HEATER ELEMENT - LEFT PANEL	SAP2422	1
11	330W HEATER ELEMENT - RIGHT PANEL	SAP2422	1
12	330W HEATER ELEMENT - BACK PANEL	SAP2422	1
13	125W HEATER ELEMENT - FLOOR	SAP2701	1
14	180W HEATER ELEMENT - BENCH	SAP70609	1
15	HEATER ELEMENT COVER - LEFT PANEL	SAP70676	1
16	HEATER ELEMENT COVER - RIGHT PANEL	SAP70676	1
17	HEATER ELEMENT COVER - BACK PANEL	SAP70607	1
18	HEATER ELEMENT COVER - FLOOR		1
19	DOOR HANDLE	SAP5007	1 SET
20	MAGAZINE RACK	SAP2414	1
21	CUP HOLDER	SAP2444	1
22	BACKREST	SAP2412	1
23	2" (50MM) SCREWS	SAP2411	2
23	1-1/2" (40MM) SCREWS	SAP2411	14
23	1-1/8" (30MM) SCREWS	SAP2411	2
23	3/4" (20MM) SCREWS	SAP2411	18
*	GLASS DOOR	SAP5000	1
*	DOOR HINGES	SAP24154	2
*	GLASS WINDOW FRONT PANEL	SAP70606	1
*	BUCKLES	SAP2607	12
*	VENTILATION COVER FOR SA2402	SAP70608	1
*	MP3 PLAYER	SAP7105	1
*	MAIN POWER CABLE	SAP2703	1
*	POWER SUPPLY BOX	SAP24071	1
*	THERMOSTAT WIRE	SAP25314	1
*	CONTROL PANEL	SAP5008	1
*	SPEAKERS	SAP2416	2
*	INTERIOR LIGHT FIXTURE (W/ BULB)	SAP2604	1
*	GLASS CLIPS	SAP2537	2
*	DOOR MAGNETS	SAP25371	2
*	COLOR THERAPY LIGHT	SAP5009	1
*	POWER SUPPLY RECEPTACLE	SAP24073	1
*	20 AMP OVERCURRENT PROTECTOR	SAP2529	1
*	CIRCUIT BOARD FOR SA3202, SA3209	SAP2428	1

*Pre-installed

PARTS SCHEMATIC

SA3202

This drawing is for illustrative purposes only. It will not match your sauna exactly, but will indicate the location of similar parts. Illustrations are not to scale.

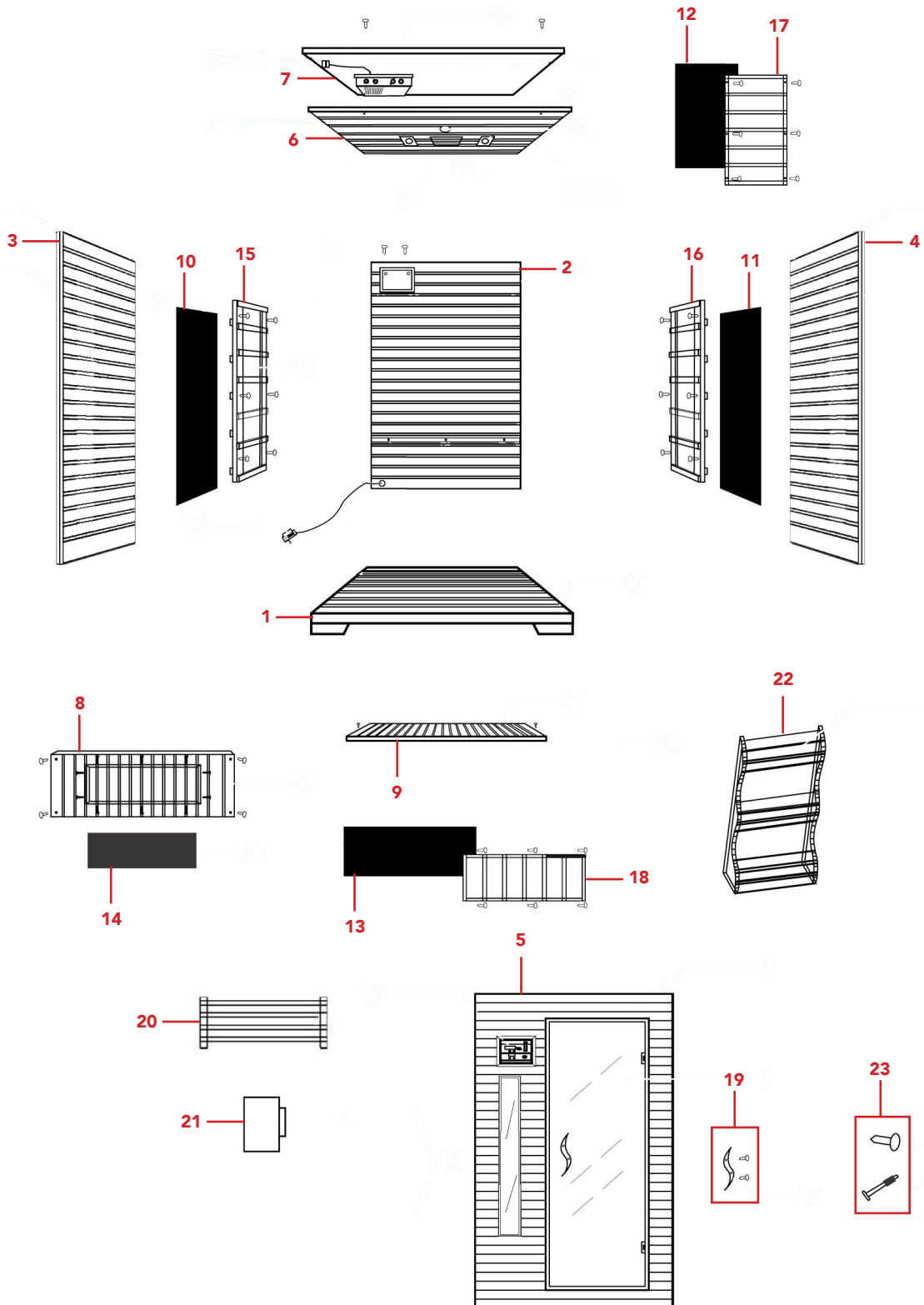

REPLACEMENT PARTS (CONT.)

SA3209 TWO-PERSON HEMLOCK MAJESTIC SAUNA WITH CARBON HEATERS

REF. #	DESCRIPTION	PART NUMBER	QTY.
1	FLOOR	SAP5016	1
2	BACK PANEL	SAP5012	1
3	LEFT PANEL	SAP5013	1
4	RIGHT PANEL	SAP5014	1
5	FRONT PANEL WITH GLASS DOOR	SAP5011	1
6	ROOF	SAP5015	1
7	ROOF COVER	SAP4609	1
8	BENCH HEATER PANEL	SAP4643	1
9	BENCH SEAT	SAP4454	1
10	OXYGEN IONIZER	SAP2409	1
11	330W HEATER ELEMENT - LEFT PANEL	SAP2422	1
12	330W HEATER ELEMENT - RIGHT PANEL	SAP2422	1
13	330W HEATER ELEMENT - BACK PANELS	SAP2422	2
14	225W HEATER ELEMENT - BENCH	SAP2421	1
15	180W HEATER ELEMENT - FLOOR	SAP2419	1
16	HEATER ELEMENT COVER - LEFT PANEL	SAP70676	1
17	HEATER ELEMENT COVER - RIGHT PANEL	SAP70676	1
18	HEATER ELEMENT COVER - BACK PANEL	SAP70611	1
19	HEATER ELEMENT COVER - FLOOR	SAP4642	1
20	MAGAZINE RACK	SAP2414	1
21	CUP HOLDERS	SAP2444	2
22	DOUBLE TOWEL HOOK	SAP2460	1
23	DOOR HANDLE	SAP5007	1 SET
24	BACKRESTS	SAP2412	2
25	2" (50MM) SCREWS	SAP2411	4
25	1-1/2" (40MM) SCREWS	SAP2411	10
25	1-1/8" (30MM) SCREWS	SAP2411	6
25	3/4" (20MM) SCREWS	SAP2411	24
*	GLASS DOOR	SAP5010	1
*	METAL GLASS CLIPS	SAP2537	2
*	DOOR MAGNETS	SAP25371	2
*	DOOR HINGES	SAP24154	2
*	BUCKLES	SAP2607	12
*	MAIN POWER CABLE	SAP2703	1
*	POWER SUPPLY BOX FOR SA3202, SA3209	SAP24071	1
*	POWER SUPPLY RECEPTACLE FOR SA3202, SA3209	SAP24073	1
*	CIRCUIT BOARD FOR SA3202, SA3209	SAP2428	1
*	20 AMP OVERCURRENT PROTECTOR	SAP2529	1
*	THERMOSTAT WIRE	SAP25314	1
*	CONTROL PANELS FOR SA3202, SA3209	SAP5008	1
*	SPEAKERS	SAP2416	2
*	INTERIOR LIGHT FIXTURES (W/BULB)	SAP2604	2
*	EXTERIOR LIGHT FIXTURES (W/BULB)	SAP2604	2
*	COLOR THERAPY LIGHT	SAP5009	1
*	MP3 PLAYER	SAP7105	1
*	GLASS WINDOW FRONT PANELS	SAP70606	2
*	VENTILATION COVER FOR SA3209	SAP70610	1

*Pre-installed

PARTS SCHEMATIC

SA3209

This drawing is for illustrative purposes only. It will not match your sauna exactly, but will indicate the location of similar parts. Illustrations are not to scale.

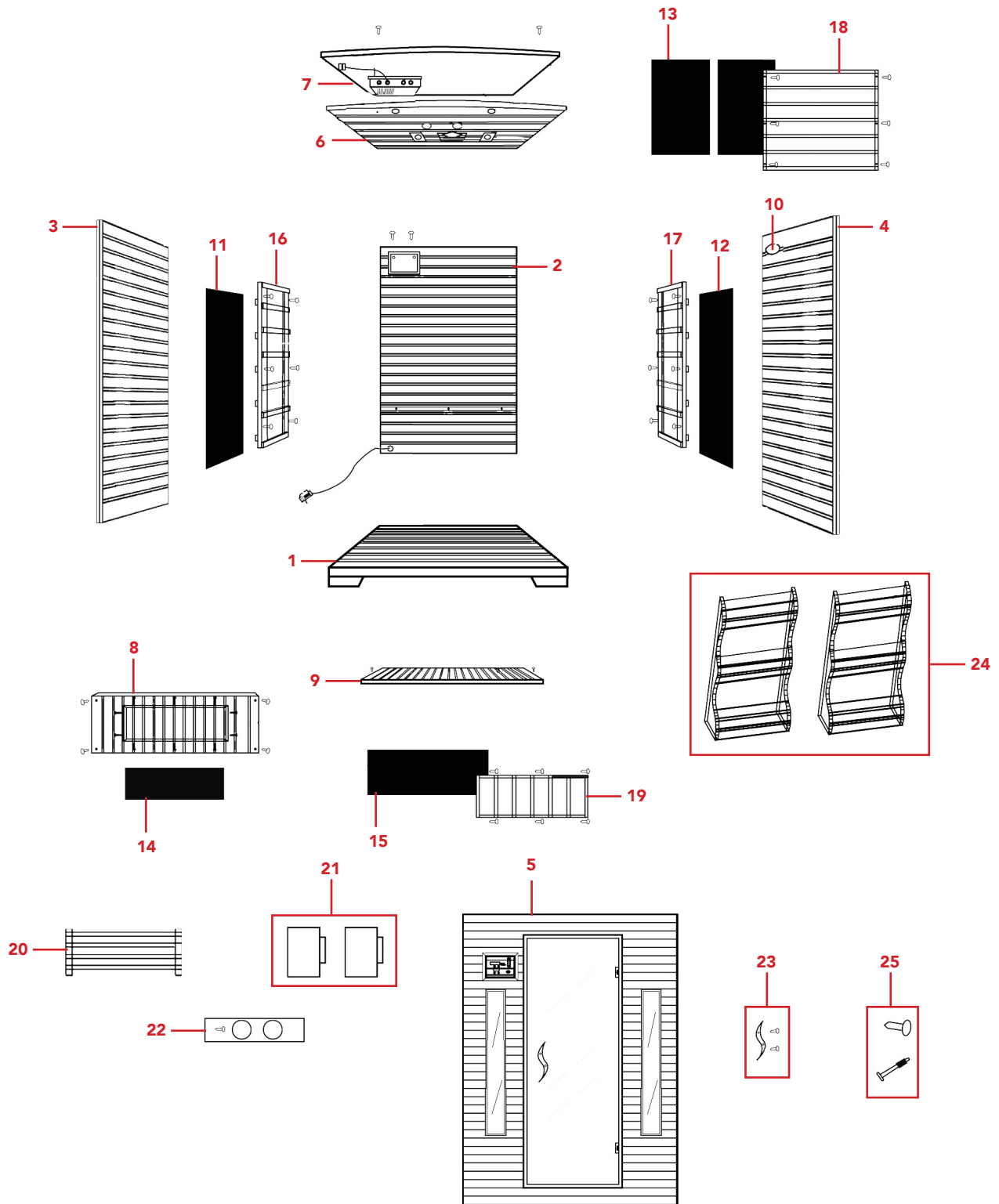

SAUNA ASSEMBLY INSTRUCTIONS

1. Begin assembly by determining an appropriate location for your sauna - see ASSEMBLY TIPS & WARNINGS (Page 3) for details. Attach the BACK PANEL to the FLOOR by lining up the BACK PANEL with the groove in the back of the FLOOR.



2. Attach the LEFT PANEL to the FLOOR. Buckle the LEFT PANEL to the BACK PANEL.



NOTE: When buckling the panels, make sure all the panels fit together snugly, with the side wall end fitting in the groove, and the outer trim overlapping the wall.



3. Attach the RIGHT PANEL to the FLOOR. Buckle the RIGHT PANEL to the BACK PANEL.



SAUNA ASSEMBLY INSTRUCTIONS (CONT.)

4. Attach the FLOOR HEATER to the FLOOR with 1-1/2" SCREWS. Connect the heater plug.

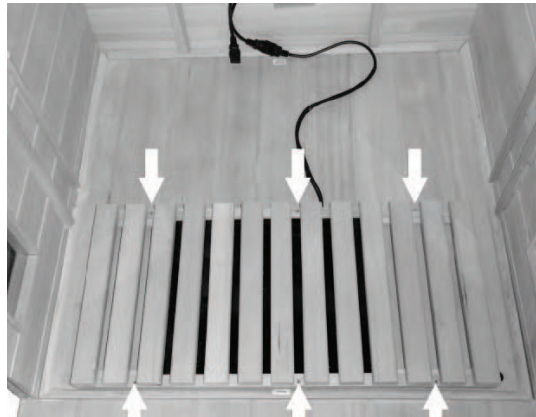

5. Slide the BENCH HEATER PANEL into panel between the LEFT and RIGHT PANELS. Connect the heater plug. Make sure the FLOOR HEATER cable is placed through the groove in the bottom of the BENCH HEATER PANEL.



NOTE: When performing Step 5 above, you may need to move the wall out slightly to accommodate inserting the BENCH HEATER PANEL.

6. Attach BENCH SEAT with 2" SCREWS.



SAUNA ASSEMBLY INSTRUCTIONS (CONT.)

7. Attach the FRONT PANEL to the FLOOR. Buckle the FRONT PANEL to the LEFT AND RIGHT PANELS.



8. Lift the ROOF above the sauna, feeding the control panel and heater cables through the corresponding holes. Feed the cables for the MP3 PLAYER through the hole in the bottom of the ROOF. NOTE: For one-person models, the ROOF fits inside the four PANELS. Secure the ROOF to the sauna with 1-1/8" SCREWS. Connect the control panel and heater plugs.

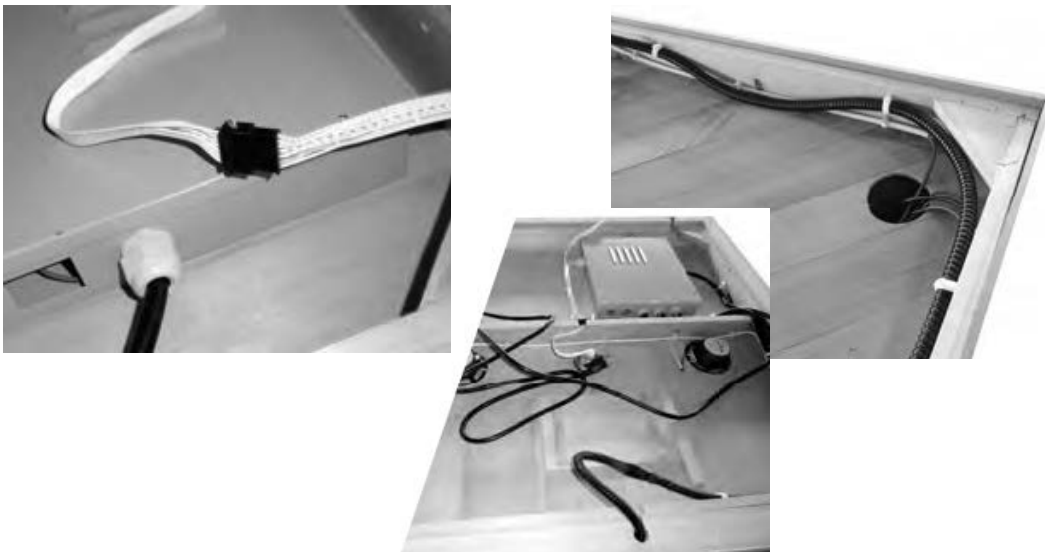

SAUNA ASSEMBLY INSTRUCTIONS (CONT.)

9. Feed the MAIN POWER CABLE through the hole in the ROOF and plug it securely into the receptacle on the back of the POWER SUPPLY BOX. Secure the ROOF COVER with 3/4" SCREWS.

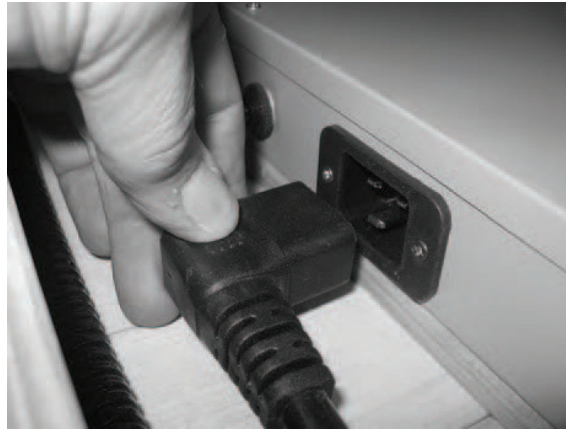

10. Attach the DOOR HANDLE to the GLASS DOOR by assembling parts (A) as shown (for the top and bottom of the handle). Insert the set screws (B) into the handle and screw them into the fitting (C).

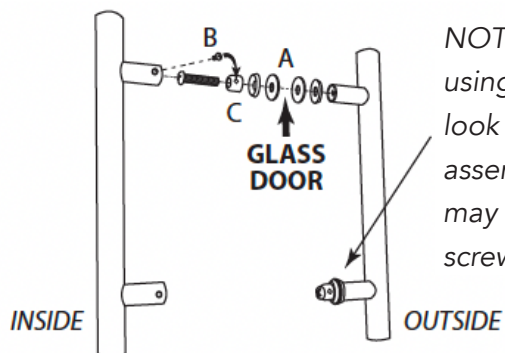

NOTE: Before attaching the inside handle and using set screws, the outside of the handle will look like this on both the top and bottom once it is assembled through the glass holes. The fittings (C) may need to be adjusted so they line up with set screw holes before inserting the screws.

11. Attach the MAGAZINE RACK with 1-1/2" SCREWS. Attach the CUP HOLDERS with 3/4" SCREWS.



NOTE: A sticker indicates the optimal position for these accessories, but attaching them is optional. Consider the position carefully before driving any screws into the sauna interior.

SAUNA ASSEMBLY INSTRUCTIONS (CONT.)

12. Attach the COLOR THERAPY CONTROL PANEL into the designated position with 2" SCREWS.
13. **SA3209:** Attach the DOUBLE TOWEL HOOK with 3/4" SCREWS.



NOTE: A sticker indicates the optimal position for these accessories, but attaching them is optional. Consider the position carefully before driving any screws into the sauna interior.

14. **SA3209:** Remove the back cover of the OXYGEN IONIZER. Unwrap and install the fragrance patch, then reattach the back cover. Attach the OXYGEN IONIZER in the designated position with two 3/4" SCREWS. Plug the power cable into the OXYGEN IONIZER.



15. Plug the main power cable into a dedicated outlet. Note: No other appliances should share the same outlet with this sauna.

CONGRATULATIONS!

The assembly of your sauna is now complete.

Please review the Assembly Tips & Warnings (Page 3) and Health & Safety Warnings (Page 4) before using your sauna.

To ensure years of trouble-free use, follow the Cleaning & Maintenance (Page 19) guidelines carefully.

DIGITAL CONTROL INSTRUCTIONS

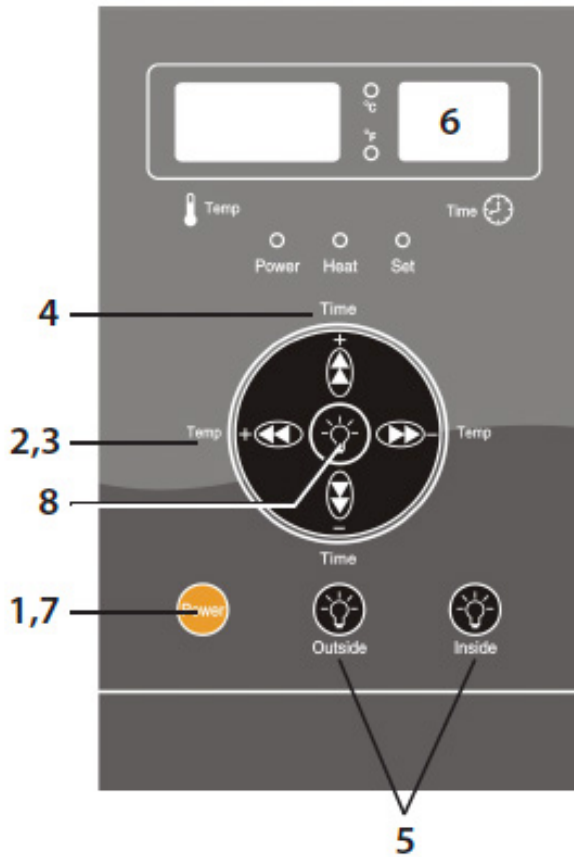

1. Press POWER to turn ON the sauna. The left window displays temperature, the right window displays time.
2. Set the desired TEMPERATURE with the (+) and (-) buttons.
3. Press and hold both (+) and (-) to switch between °F (Fahrenheit) and °C (Celsius).
4. Set the desired TIME with the (+) and (-) buttons.
5. Press INSIDE or OUTSIDE to turn on or off the corresponding light.
6. When the TIME reaches 00, the heaters will turn OFF automatically. You will hear a reminder beep when the time reaches 1 minute left.
7. After your saunas session, press POWER to turn OFF the sauna. DO NOT leave the sauna unattended while the power is on. If the sauna will not be used for a long period of time, unplug the power cord. To extend the sauna use life, shut it down for 30 minutes after 3 hours of continuous use.
8. Press the CENTER LIGHT ICON to operate the COLOR THERAPY LIGHT. See below for detailed instructions.

COLOR THERAPY LIGHT INSTRUCTIONS

1. Press the center light icon (see above) to turn ON the COLOR THERAPY LIGHT.
2. Color selection: continue pressing the center light icon for 2 seconds, the right side will show "2n", the color mode will change each time the button is pressed, while the left side will show 1L through 9L:
 - 1L: Quick color changing mode
 - 2L: Slow color changing mode
 - 3L: White color, can be used as a reading light
 - 4L-9L: Colorful mode
3. If the selection button isn't pushed for 5 seconds, the screen will return to the TIME and TEMPERATURE display mode. To set the color light again, keep pressing the center light icon.
4. Press the center light icon (see above) to turn OFF the COLOR THERAPY LIGHT.

MP3 PLAYER INSTRUCTIONS

1. Press the "POWER" button on the MP3 player. Press the "MODE" button until "AUX" appears on the screen. Other "MODE" options include the radio, USB, and the SD card slot.



A. Select "SETTINGS" on the phone



B. Select "BLUETOOTH™" and get "CONNECTED"

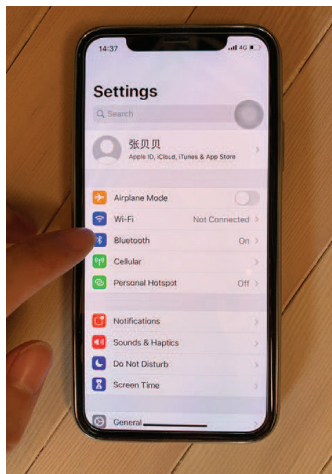

C. Select "SAUNA" and get "CONNECTED"

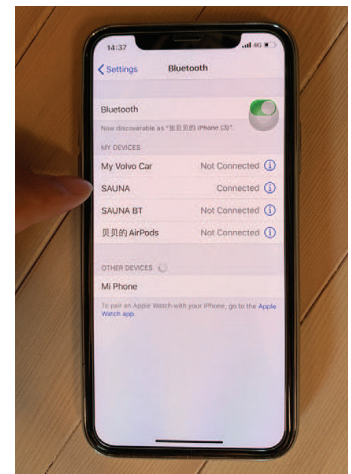

D. Select your music app of choice



E. Select a song to play

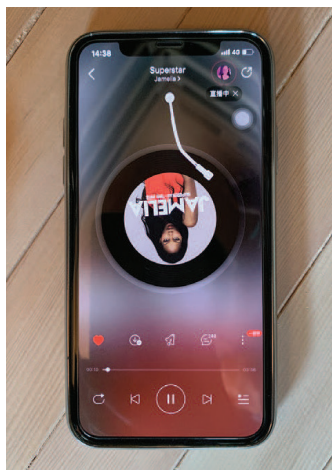

TROUBLESHOOTING GUIDE

WARNING!

- Always unplug the sauna and allow it to cool down before performing any maintenance.
- Repairs to the electrical components of the sauna should only be performed by a qualified service technician.
- Unauthorized repairs or alterations will void the manufacturer's warranty.

PROBLEM **THERE IS NO POWER TO THE SAUNA**

- Solution
1. Check that the main power cable is plugged into the wall outlet.
 2. Check that the circuit breaker for the outlet has not tripped. If the breaker has tripped, check that the amperage of the breaker is appropriate for your sauna.
 3. Check all connections to the power supply box.
 4. Check for damage to the main power cable; replace if necessary.
 5. Replace the power supply box, if necessary.

PROBLEM **ONE HEATER DOES NOT WORK**

- Solution
1. Check that all the connections are tight.
 2. Replace the heater element.

PROBLEM **NONE OF THE HEATERS WORK**

- Solution
1. Check that all the connections are tight.
 2. Replace the heater overcurrent protector, if necessary.

PROBLEM **THE CONTROL PANEL DOES NOT WORK**

- Solution
1. Check that all the connections are tight.
 2. If the numbers are scrambled or the buttons are unresponsive, replace the control panel.
 3. If the temperature indicator does not work or reads “-” or “EP”, replace the control panel.

PROBLEM **THE LIGHTS AND/OR SPEAKERS ARE NOT WORKING**

- Solution
1. Check that all of the connections are tight.
 2. Replace the light fixture, if necessary.
 3. If neither the light or the speakers are working, replace the power supply box.

TROUBLESHOOTING GUIDE (CONT.)

PROBLEM

THE SPEAKERS ARE NOT WORKING

- Solution
1. Check that the volume is not turned all the way down.
 2. Check that all the connections are tight.
 3. Replace the speaker, if necessary.

SAUNA USE DISCLAIMER

Always consult a health care provider who is knowledgeable in sauna use before using a sauna. Saunas are powerful devices and monitoring your progress by a professional that is trained in sauna use is always advisable. Variables of sauna therapy such as the health of the user, condition of the user, duration of sauna therapy, proper hydration, and electrolyte and mineral balance must be properly considered and heeded before proceeding with sauna therapy. Blue Wave's products are not registered with the United States Food and Drug Administration (FDA) as medical devices. Consult your licensed health care provider to see if our saunas are right for you. Blue Wave Products and/or its partners, associates, etc. are not liable for the use of Blue Wave's products nor any incidental or consequential damages. Under no circumstances shall Blue Wave Products or any of its representatives be held liable for injury to any persons or damage to any property. Some states do not allow exclusion or limitation of incidental or consequential damages, so the above limitations or exclusions may not apply to you. The FDA requires us to inform you that this product is not intended to diagnose or treat any disease or medical problem and is not a substitute for regular medical care from a licensed health care provider.

ENJOYING YOUR SAUNA

1. Prior to initial use, wipe down all interior surfaces of the sauna with a damp cloth.
2. Turn on the sauna and set the temperature to 104°F for one hour to burn off any factory dust.
3. Always drink plenty of water before, during, and after your sauna session to stay properly hydrated.
4. A normal sauna session should last 30 minutes or less.
5. Allow approximately 20 or 30 minutes for the sauna to warm up before entering.
6. Perspiration will begin within 15 to 25 minutes after entering the sauna.
7. Limit the use of lotions or oils on your body while using your sauna. These products can block your pores and limit perspiration, decreasing the effectiveness of your sauna session.
8. For spot treatment of a particular area, position that body part closer to the heater, allowing for deeper heating in that area.
9. During your sauna session, place towels on the bench seats and on the floor to absorb perspiration and maintain the cleanliness of your sauna.
10. Towel off excess perspiration during your sauna session to help your body perspire more freely.
11. Open the ceiling vent or the front door to allow fresh air into your sauna.
12. Allow your body to cool down following your sauna session, then rinse the perspiration off your body in a warm shower.

CLEANING & MAINTENANCE

1. Always unplug the sauna and allow it to cool down before performing any cleaning or maintenance.
2. Use furniture polish or furniture oil when cleaning the sauna exterior.
3. The sauna interior surfaces should only be wiped down with a damp cloth. Do NOT use chemicals, abrasive cleaners, or solvents on the unfinished interior wood.
4. As with all natural wood products, variations in the color and the grain as well as irregularities such as knots and fine cracks may be present. These characteristics are a part of the natural beauty of the wood and should not be considered defective.

SAUNA WARRANTY

1. This sauna has a 7-Year Limited Warranty against defects in material and workmanship from date of purchase. To receive the warranty, the card below must be completely filled out and returned within 30 days from the date of purchase. This 7-Year Limited Warranty covers the wood structure*. Heating elements and all electronics are covered by a 5-Year Limited Warranty. The MP3 player (if included with your sauna) is covered by a limited 1-Year Warranty. The light bulbs and light fixtures are covered for 90 days.
2. This product is intended to be utilized for private, non-commercial use. Blue Wave Products' sauna must be used as directed in the Product Operation Manual. Utilization of non-Blue Wave Products replacement parts or repairs which are not done by or under the direction of Blue Wave Products shall also void any warranties/guarantees, expressed or implied.
3. This warranty does not cover defects or damage due to improper installation, alteration, accident, installation of unauthorized parts, or any other event beyond the control of the Blue Wave Products. Defects or damage resulting from misuse, abuse, or negligence will void this warranty. This warranty does not cover scratching or damage that may result from normal usage.
4. Please notify Blue Wave Products in advance of any sauna warranty claim prior to shipping the sauna back. Contact our warranty claim department at warranty@bluewaveproducts.com. This warranty becomes valid at time of purchase and terminates either by specified time frame listed above, owner transfer, or relocation.
5. This warranty is nontransferable and is expressly limited to the repair or replacement of the defective product. During the warranty period, Blue Wave Products shall repair or replace defective parts at no cost to the purchaser. Shipping charges and insurance are not covered and are the responsibility of the purchaser. Labor charges and related expenses for removal, installation, or replacement of the product or components are not covered under this warranty.
6. If the warranty claim department determines that the item must be returned, it must be returned with freight prepaid and a receipt showing date of purchase, purchase price, and the dealer from which the sauna was purchased. **No warranty claim will be honored without a receipt.**
7. Warranty claims will only be resolved with the repair of the current product or shipment of a replacement product or parts at the sole discretion of Blue Wave Products. NO REFUNDS will be given.
8. Blue Wave Products reserves the right to make substitutions to warranty claims if parts are unavailable or obsolete.
9. Blue Wave Products shall not be liable for loss of use of the product or other consequential or incidental costs, expenses, or damages incurred by the consumer of any other use. The user assumes all risk of injury resulting from the use of this product.
10. Improper installation, misuse, or damages resulting from acts of nature will render this warranty null and void.
11. This warranty is in lieu of all other warranties expressed or implied and no responsibility is assumed for future damage due to misuse. This sauna is intended for INDOOR USE ONLY – outdoor installation of the sauna WILL VOID THE WARRANTY. Additional actions that will void the warranty are: Use of lacquer or paints on any part of the sauna or placing the sauna on a non-approved surface.

* Surface cracks are NOT considered defects in material or workmanship, as they are normal characteristics of all wood. This includes minor cracks due to wood expansion and contraction. Note: since the wood used in construction has been kiln dried, a certain amount of expansion and contraction is expected in the wood within a sauna environment. Also, over time the sauna wood may darken or change color tones. This color change is considered normal aging and is not covered under warranty.

SAUNA WARRANTY (CONT.)

To send in this warranty card, fill it out, detach it, and mail it to the following address:

ATTN: Heatwave Sauna Warranty
Blue Wave Products
101 N. Raddant Rd.
Batavia, IL 60510

For further warranty information or inquiries, please call our Consumer Hotline 1-800-759-0977 or email at warranty@bluewaveproducts.com.



SAUNA WARRANTY REGISTRATION FORM

Date Purchased: _____ / _____ / _____

Name: _____

Address: _____

City/State/Zip: _____

Phone: () _____ Email: _____

Purchases from: _____

Item Number: _____ Purchase Price: _____

*To ensure product warranty, complete all information and mail this card
within 30 day of purchase.*