

## XW-70 Grande Wall Wash **DESIGNER PLUS**



---

PROJECT

---

CATALOG #

---

TYPE

---

NOTES

---

The new Exa Collection offers high-output performance with low-voltage simplicity. Combining light output of 1,200 lumens with top-tier integrated LED technology, the Exa Wall Wash offers a 135° ultra-wide flood beam spread, two correlated color temperatures, and up or down mounting orientations. Featuring a patent-pending adjustable body, robust mechanical seals, and an IP66/IP67 rating, flexibility and durability are no longer a trade-off.

### Quick Facts

- Up or down mounting orientations
- Die-cast aluminum with two-layer anodization and a TGIC powder-coat finish
- Cree® integrated LED up to 1,200 lumens
- Two correlated color temperature (CCT) options: 2,700K and 3,000K
- 135° ultra-wide flood beam spread
- Available with ground stake or Mini J-Box (MJB)
- Compatible with Luxor® Technology
- Input Voltage: 10 to 15 V

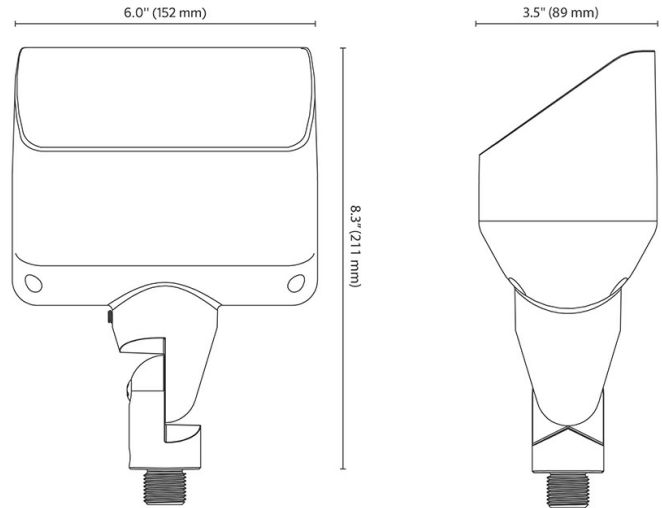

# XW-70 Grande Wall Wash SPECIFICATIONS

Output	H1*	ZDC**
Total Lumens (lm)	1,180	450-1,000
Input Voltage	10 to 15 V	11 to 15 V
Input Power (W)	18.0	21.0
Power Consumption (VA)	23.0	25.0
Efficacy (Lumens/Watt)	67	64
Color Rendering Index (CRI)	84	-
Maximum Candela (cd)		
Very Wide Flood (135°)	527	634
Luxor Compatibility		
Default	Zoning	Zoning
ZD Option	Zoning/Dimming	Zoning/Dimming
ZDC Option	-	Zoning/Dimming/Color
Minimum Rated Life (L70)	72,000 hrs	55,000 hrs

\*\*Measured with all four colors turned on at 100%

# XW-70 Grande Wall Wash SPECIFICATIONS

## FX Luminaire

FX Luminaire is an industry-leading manufacturer of landscape and architectural lighting products with a focus on the advancement of LED technology and digital lighting control with zoning, dimming, and color adjustment capabilities. We offer a full spectrum of specification-driven lighting fixtures that can be utilized to create elegant, cutting-edge landscape lighting systems for commercial or residential applications. Our products are available exclusively via our extensive professional distributor network.

## Materials

Die-cast A380 aluminum housing and shield with stainless steel hardware. Die-cast zinc/aluminum alloy knuckle.

## LED

Integrated module with Cree LEDs. Gold-plated connectors and potted driver for maximum reliability and corrosion resistance. Proprietary on-board intelligent driver uses firmware-controlled temperature regulation, maximizing LED life.

## Optics

Color temperature defined by part number.

## Threads

1/2"-14 NPSM

## Dimming

Primary: Consult transformer specifications Secondary: Luxor® control or a trailing-edge (reverse phase-cut) dimmer.

## Adjustability

Compress-and-lock features prevent slip after installation. Offers 9° increments of adjustability over 220° of vertical alignment.

## Configuration

Integral driver.

## Finish

Two-layer protection of sulfuric acid anodization and polyester TGIC powder-coat finish, providing superior outdoor weathering in all conditions. Tested to ASTM standards.

## Hardware

Stainless steel adjustability lock screw. Includes 10" (254 mm) ABS slotted ground stake or MJB Mini-Junction Box.

## Wiring

18 AWG (1 mm); SPT-1W; 220°F (105°C); 300 V; 10' (3 m) length, measured from the light aperture. International ("e") length is shorter.

## Sockets

Nonreplaceable Molex® connector with Moisture Block™ Technology to prevent moisture from wicking up into sealed areas of the luminaire.

## Power

Input 10–15 Vac/dc, 50/60 Hz. for white, and 11–15 Vac, 50/60 Hz. for RGBW (ZDC). Remote transformer required (specify separately).

## Housing

Die-cast aluminum housing with potted driver board and capacity for H1 and ZDC integrated LEDs.

## Glare Control

Die-cast, threaded aluminum shield with 35° cutoff and mechanical seal.

## Weight

3.2 lb / 1.5 kg

## Lens

Tempered glass lens with shock resistance and high tolerance for thermal expansion and stress.

## International Compliance

Compliant per IEC 60598-1 and IEC 60598-2-4 by selecting the "e" version.

## Ambient Operating Temperature

0°F to 140°F (-18°C to 60°C)

## Sustainability

Innovation meets conservation in the design and manufacturing of our products. Where we can, we use recycled materials while maintaining superior functionality. Our LED products provide high-quality light at optimal energy efficiency, lifespan, and durability.

## Installation Requirements

Designed for installation in either upward or downward directions.

## Control

ZD or ZDC options utilize Luxor® Technology to zone light fixtures in up to 250 groups, dim each group in 1% increments between 0 and 100%, or change to one of 30,000 colors with RGBW LEDs. Select the ZD option for zoning/dimming or ZDC for zoning/dimming/color. Standard fixture is zoneable with Luxor Controller.

## Manufacturing

ISO 9001:2015 certified facility







## Warranty

10-year limited warranty

## Listings



# XW-70 Grande Wall Wash ORDERING INFORMATION

Fixture Control		Power	Color Temp	Compliance	Mounting	Finish
<b>XW-70</b>	<b>[Default]</b> Zone with Luxor, On/Off, Phase Dimmable	<b>H1</b> 18.0 W / 23.0 VA	<b>W</b> Warm (2700K)	<b>[Default]</b> North America (UL Listed)	<b>[default]</b> Ground Stake	<b>BZ</b> Bronze Metallic 
	<b>ZD</b> Zone/Dim with Luxor	<b>[default ZDC option]</b> 21.0 W / 25.0 VA	<b>S</b> Soft (3000K)	<b>E</b> International (CE Certified)	<b>MJ</b> Mini-Junction Box	<b>FB</b> Black 
	<b>ZDC</b> Zone/Dim/Color with Luxor		<b>[Default]</b> RGBW, ZDC Option Required			<b>DG</b> Desert Granite 
						<b>WI</b> Weathered Iron 
						<b>SB</b> Sedona Brown 
						<b>FW</b> Flat White 
						<b>SV</b> Silver 































EXAMPLE FIXTURE CONFIGURATION: *XW-70-XX-XX-X-X-XX-XX*

XW-70, H1, Wall Wash - Illuminance at a Distance

Distance	Center Beam fc	Beam Width	
Feet (Meters)	Foot-Candles (Lux)	Vertical : 85 °	Horizontal : 95 °
6.0' (1.8 m)	14.6 fc (157 lx)	10.7' (3.3 m)	12.9' (3.9 m)
12.0' (3.7 m)	3.7 fc (39 lx)	21.4' (6.5 m)	25.8' (7.9 m)
18.0' (5.4 m)	1.6 fc (17 lx)	32.1' (9.8 m)	38.6' (11.8 m)
24.0' (7.3 m)	0.9 fc (10 lx)	42.8' (13 m)	51.5' (15.7 m)
30.0' (9.1 m)	0.6 fc (6 lx)	53.6' (16.3 m)	64.4' (19.6 m)







MOUNTING OPTIONS: Specify Separately

Mounts	Catalog No.		Mounts	Catalog No.	
Long Slot Spike	250015840000		Three-Prong Spike	250020020000	
Lock Ring	250030410000SP		Riser, Angled Sign-Light	C-Riser	
Straight Coupling	COUP-XX*		CE Certified Spike	eKitSpike	
90° Coupling	ELBW-050-XX*		Gutter Mount	GM-SS	
Ground Mount with 1/2" Thread	GM-XX*		Line Mount	LNМ	
Mini J-Box for 1/2" Thread	MJB-050-XX*		Mini Mount	MM-050-XX*	
ProAim® Ratcheting Spike	PARS		Post Mount	PM-XX*	
Riser, Straight	S-Riser		Super J-Box Spike	SJ-XX*	
TreeBox® Mount with 1/2" Thread	TB-XX*		T-Mount Coupling with 1/2" Thread	TMNT-050-XX*	
Tree Ring Junction Box, LL-Style Conduit Body	TR-JB-LL-XX*		Tree Ring Junction Box, T-Style Conduit Body	TR-JB-T-XX**	
Tree Ring	TR-YY*-6P-XX*		VersaBox® Mount with 1/2" Thread	VB-050-XX*	
Variable Height Riser for Up Lights	VHR-UL		Single-Gang Wall Plate with 1/2" Thread	WP-1G-050-XX*	
Round Wall Plate with 1/2" Thread	WP-RD-050-XX*		1.0" (25 mm) Copper Riser for GT Path Light	YY*-R-GT-XX*	
Sign Light Riser, Aluminum	YY*-R-SL-XX*		Aluminum Riser, 3/4" Diameter	YY*-R-XX*	

LENS OPTIONS: Specify Separately



Lenses	Catalog No.		Lenses	Catalog No.	
Optics Kit, Exa Collection, ZDC-6	KITOPEXAZDC		Optics Kit, H1, Flood for Exa Directional and In-Grade Lights	KITOPXB35H1FL	
Optics Kit, H1, Spot for Exa Directional and In-Grade Lights	KITOPXB35H1SP		Optics Kit, H1, Wide Flood for Exa Directional and In-Grade Lights	KITOPXB35H1WF	

POWER OPTIONS: Specify Separately

Power	Catalog No.		Power	Catalog No.	
Low-Voltage Dimmer	DIM-LV		Luxor CUBE- Low-voltage	LCM-LV	
Mini Plug-In Transformer, 30 W	MT-30W		Step-Down Transformer, Dimmable (120 V to 12 V)	ST-120-DIM	
Step-Down Transformer (120V to 12V)	ST-HV		Step-Down Transformer, UV (120/277 V to 12 V)	ST-UV	
Surge Protection Module	SURGE-MOD				



SPLICING OPTIONS: Specify Separately

Splicing	Catalog No.		Splicing	Catalog No.	
Brass Lug Wire Connectors, 2-pack	WCHSBS2		Brass Lug Wire Connectors, 50-item Bulk Pack	WCHSBS50	
Heat Shrink Wire Connectors, 20-pack, Medium	WCHSMD20		Heat Shrink Wire Connectors, 20-pack, Small	WCHSSM20	