

*Water
Features,
Welding,
Sheet Metal,
Fabrication
& More*

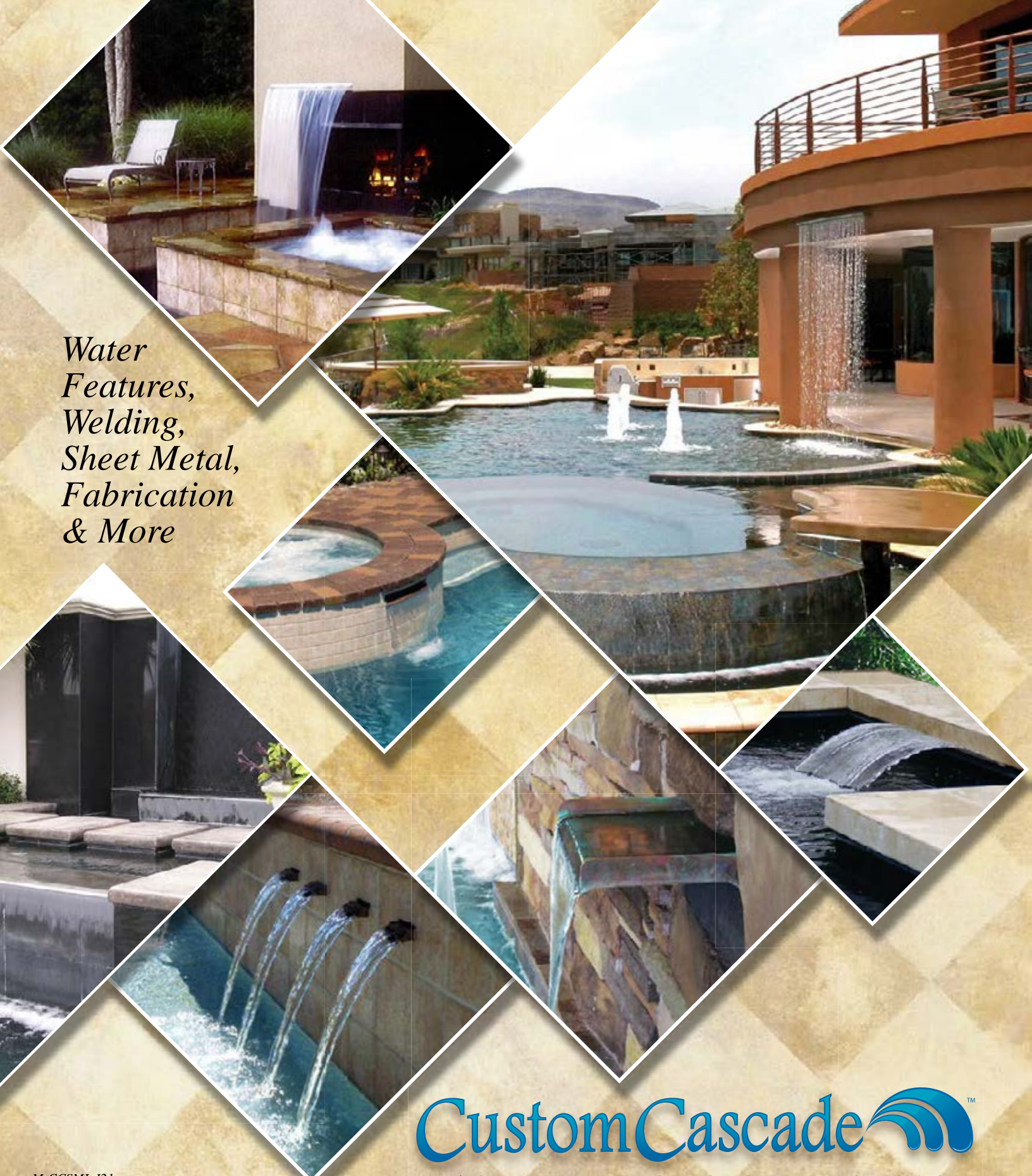

M-CCSML-121
List Price U.S. \$6.95

Custom Cascade 

THE ONLY LIMITATION IS YOUR IMAGINATION!

PRODUCT GUIDE

FROM CONCEPT TO REALITY

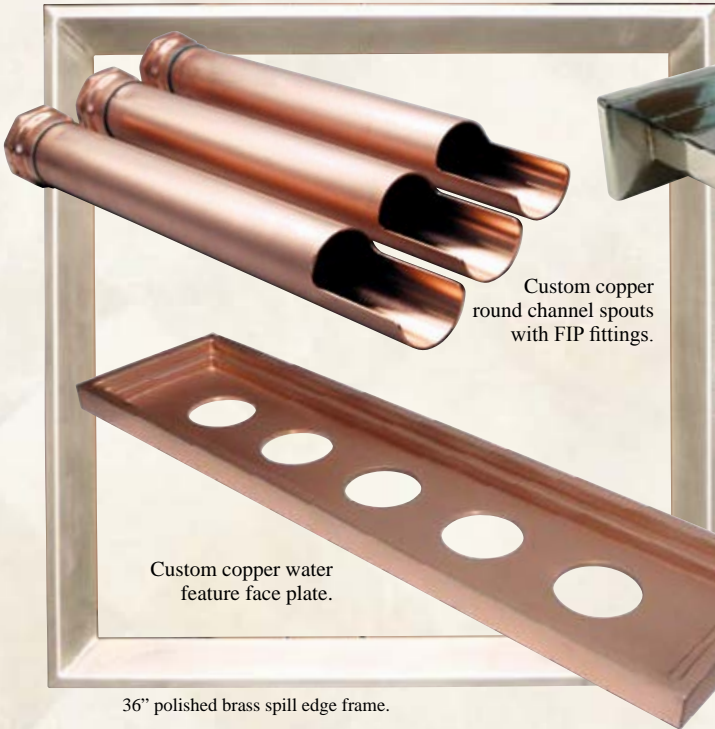

Custom copper round channel spouts with FIP fittings.

Custom copper water feature face plate.

36" polished brass spill edge frame.

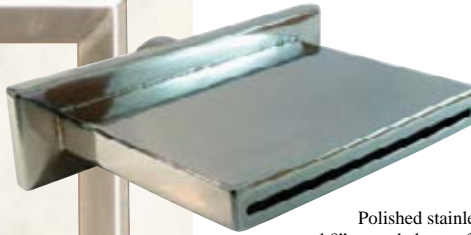

Polished stainless steel 8" extended waterfall for interior application.



BEFORE

NOBODY DOES CUSTOM LIKE CUSTOM CASCADE!

Call for a quote or just to get the information you need to move in the right direction. With decades of experience, our staff can help you realize your vision. To start the process, simply go to our website and download the appropriate documents from our "Quote Forms" menu option. Fill it out and fax to (800) 434-7660 or email it to cs@oreqcorp.com.

Wet Wall application shown before and after.



AFTER



12' concave circle sheeting waterfall feature with bottom inlets.



Compound radius ABS SheetFall.

TEST, TEST AND RE~TEST!

Every one of our waterfalls, be it a standard 12 inch ABS or a 18 foot custom stainless steel rainfall, gets thoroughly tested.

Any necessary adjustments are made and the unit is tested again.

We don't ship it unless it passes our quality control inspection.



High



Medium

Low

Variety of flow pressure shows dramatic differences from high to low pressures (counter clockwise).



Compound radius curved vessel in white ABS plastic.



Brushed copper architectural water feature with a 32" bowl and a 45" long water channel. Copper was left expolised in its natural state to allow a patina to develop.

Metal Works

Custom Cascade builds years of waterfall experience into each and every piece. Add that to the metal work capabilities below, and you have a custom fabrication resource like no other.

- Hydraulic Press Break & Shearing
- MIG & TIF Welding
- Bead Rolling
- Radius Metal Forming
- Multiple Turret Punches
- Polishing and Finishing
- Milling and Lathe Work
- Plasma Cutting

We also offer metal finishes in brushed, polished and clear coating on our brass, copper and stainless steel. In addition, brass and copper are available in antiqued, verdigris and antiqued verdigris, giving you the option to get an immediate patina, let nature do it over time.



Specialty Features

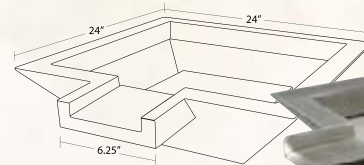
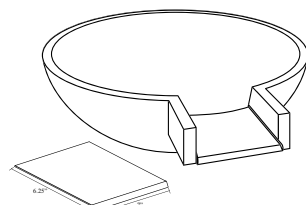

TRAVERTINE URNS

Always a classic look, these travertine urns recall the luxurious baths of Rome to create a relaxing spa feature. Outside measures 30" wide x 10" high with a 9" wide x 6" long spout. For a clean sheeting effect, order a spill edge to get that finished look.

Material: Natural ceramic travertine & resin. Standard 2" inlet on bottom. Use of a SpillEdge is suggested.

SQUARE POT

High class and modern styling pour out of this new modern classic. Adaptable for both water and fire, our square pot is available in stainless, copper or brass, in brushed, polished or antique finishes. Standard square pot measurements: top 24" square, bottom 12" square, 7.25" high with a 6.25" w x 5" d spout. Available in various dimensions.

Material: Stainless steel, copper, brass. Standard 1.5" inlet on bottom. Spilledge is integrated into spout of unit.

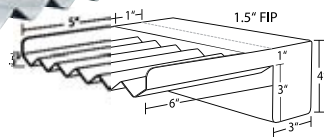
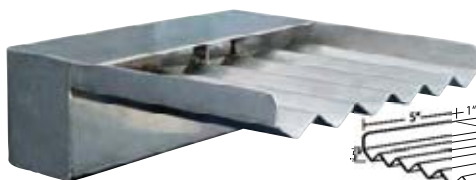

RIVERFALL

The unique rippled edge design of our RiverFall delivers delicate channels of water at low volume levels to a sheet at high levels. All the functions of an OpenTop waterfall with the benefits of grooves for texture. Standard depth of lip is 6" with 1/2" high channels.

Material: Stainless steel, copper, brass. 1.5" inlet on bottom or back.

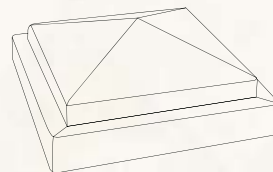

COLUMN CAPS

Rustic or refined, nothing finishes off a post, pillar or column like our caps. When coordinated with other features or color schemes, metal caps add protection, beauty and that extra touch that rounds out the pool or yardscape. Shown above in a classic pyramid shape, cap styles range from simple flat tops to multi-tiered.

Material: Stainless steel, copper, brass. Available in finishes below.

Metal features are available in:
Brass Copper Stainless Steel



Finishes shown on brass. Finishes also available on copper.
Stainless steel available in high polish.

Clearcoat Antiqued Verdigris Antique Verdigris



ABS Colors Available:

White Tan Gray

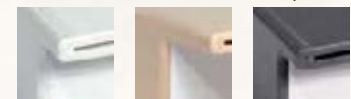

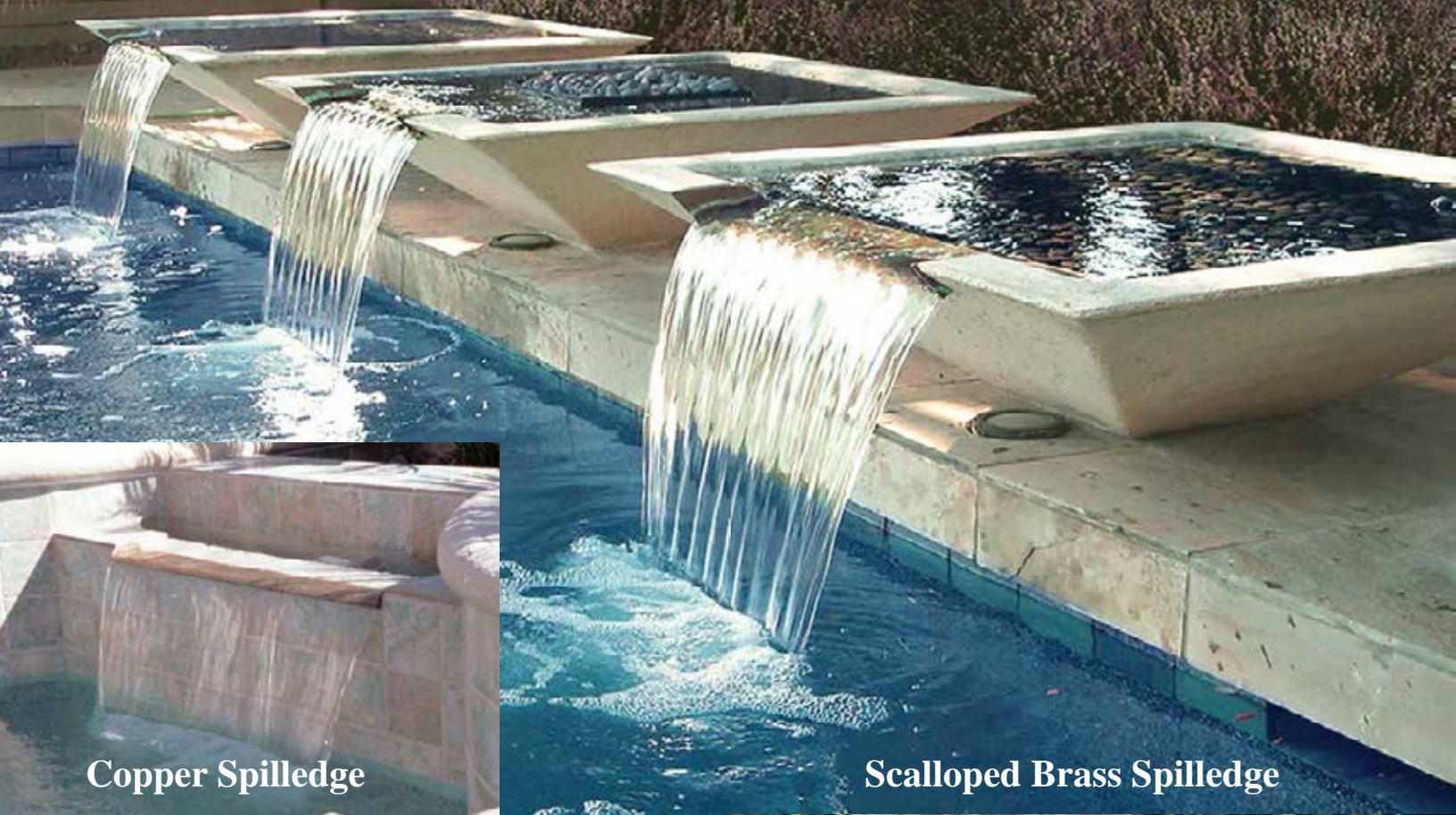

Copper Spilledge

Scalloped Brass Spilledge

SPILLEDGES

Our spilledges are the backbone of many of our water features. The proprietary leading edge design creates a smooth, sheeting water flow. By creating a flow away from walls, spilledges help prevent calcium build-up and wall corrosion.

Available in metal only:
Copper - Brass - Stainless

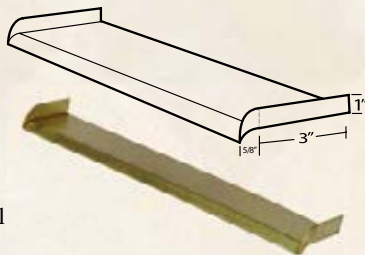

SPILLWAYS

Spillways integrate our edge smoothing no-drip lips into a feature that can be imbedded into walls. Like spilledges, spillways create a smooth, sheeting action and are ideal for achieving a transition to a lower body of water.

Available in metal only:
Copper - Brass - Stainless

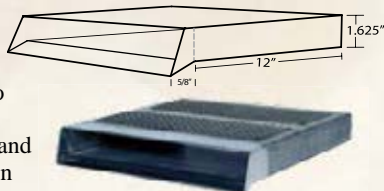

Convex Copper Spillway

Metal features are available in:
Brass Copper Stainless Steel

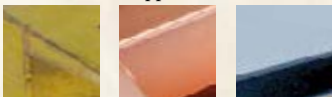

Finishes shown on brass. Finishes also available on copper.
Stainless steel available in high polish.

Clearcoat Antiqued Verdigris Antique Verdigris



ABS Colors Available:

White Tan Gray

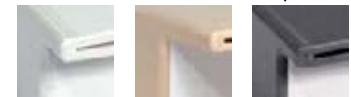



Channel Spouts

CHANNEL SPOUTS

Perfect for achieving an imbedded flow path. Channel spouts create a less refined but more active effect in the water. Templates to achieve perfect spout spacing are available. **Available in metal and ABS.**

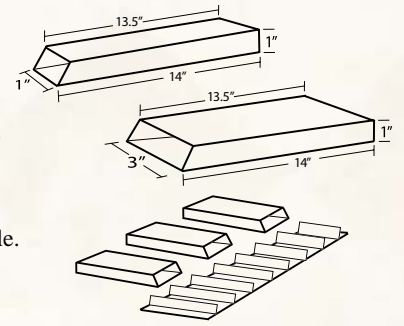

OPEN TOP WATERFALL

Because the Custom Cascade water baffle evens out forced water flow, open top waterfalls can achieve smooth water flow over long and varying length. Additionally, unique effects can be achieved by changing the length of the lip extension. **Available in metal only. Straight, concave, convex, and compound shapes are available.**

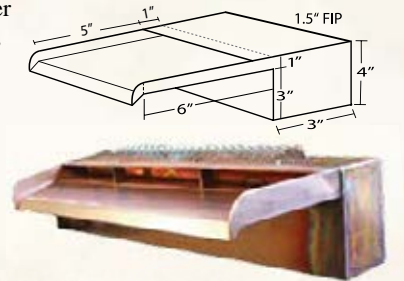

Copper Open Top Waterfalls With Extended Lip

Metal features are available in:
Brass Copper Stainless Steel



Finishes shown on brass. Finishes also available on copper.
Stainless steel available in high polish.



ABS Colors Available:
White Tan Gray



Concave Sheeting WaterFall with Extended Lip

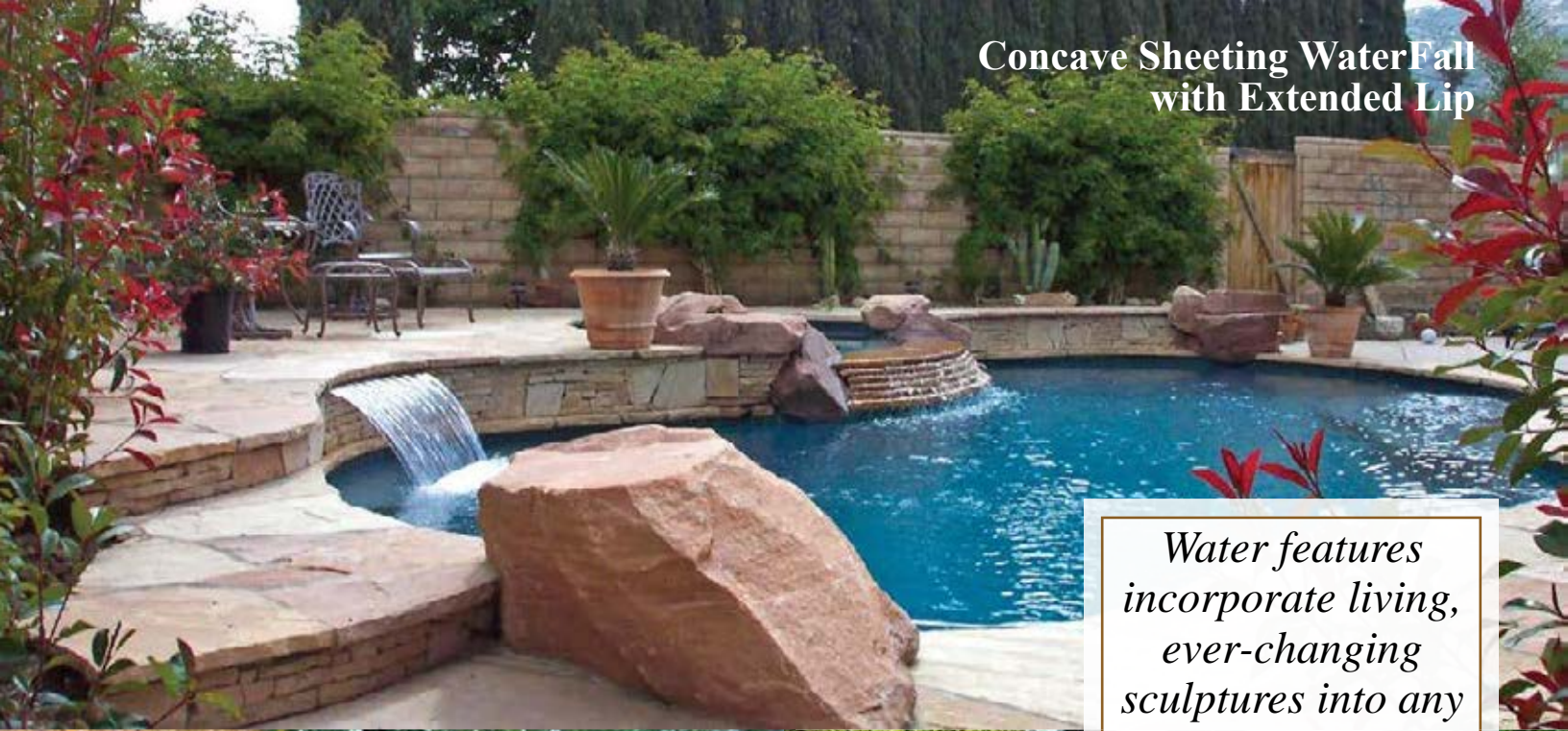

Water features incorporate living, ever-changing sculptures into any pool structure.



Curved Vessel Sheeting WaterFall



Sheeting WaterFall

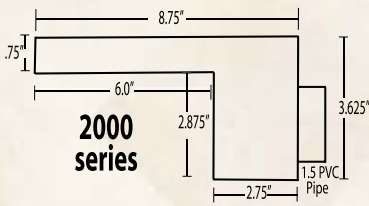

ABS Plastic Sheeting Waterfall



Gray ABS

WATERFALLS

Perhaps our best selling water feature types because of their sheer visual impact and flexibility. Typically a hidden feature, our WaterFalls and their variations come in virtually any shape and size. Effects from a caressing sheet of water to a torrential rain storm can be attained with the right combination of styles. Available in metal and ABS as shown below.

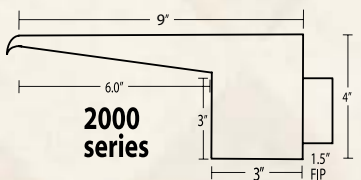

Metal Sheeting Waterfalls

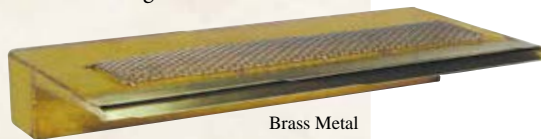

Brass Metal

Metal features are available in:



Finishes shown on brass. Finishes also available on copper. Stainless steel available in high polish.



ABS Colors Available:





Stainless RainCurtain



ArcFall



RainFall



RainCurtain90

ARCFALLS, RAINARCS, RAINFALLS & RAINCURTAINS

Redirecting water is what these features are all about: from a gentle sheeting arc at the edge of the pool to full rainwall effects inside. Our arcs and curtains come in ABS plastics or metal, with 45 degree arc projections and 90 degree curtain angles. In addition, lip lengths, 90 degree downspouts and rain hole patterns make these features very diverse. Let your imagination take reign...we'll be sure to step up to the challenge.

Available in Metal: Copper - Brass - Stainless
ABS: White - Tan - Gray

ArcFalls are available in ABS only.

Straight, concaved, convexed, compound or corner structures available. Standard measures vary widely.

AVAILABLE RAIN PATTERNS RainFalls, RainCurtain, RainCurtain 90°

1" Spacing	•	•	•	•	•
1/2" Spacing	•	•	•	•	•
1/2" Spacing Offset	•	•	•	•	•

holes are 3/16"

Arcs & RainArcs

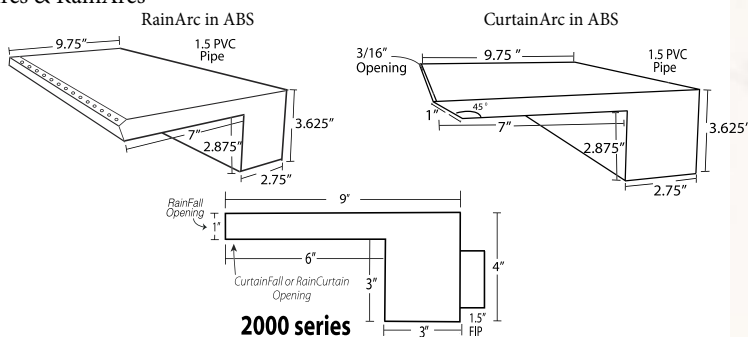

ArcFall ABS



RainArc ABS

CurtainFall 90 in ABS



Metal features are available in:
Brass Copper Stainless Steel



Finishes shown on brass. Finishes also available on copper. Stainless steel available in high polish.

Clearcoat Antiqued Verdigris Antique Verdigris



ABS Colors Available:

White Tan Gray



SCUPPERS & STEP SCUPPERS

Scuppers are a great addition for architectural detail. Both scupper models come with our proprietary no-drip lip. Baffle chambers reduce water turbulence and deliver smooth, sheeting water at low water volumes while higher volume will create more active water profiles. Available in metal only. Step Scupper standard dimensions: depth 8.5" bottom, 5" top, 4" height with a 5/8" lip depth. Scupper standard dimensions: depth 5.75" top, 1.75" height at back and a 5/8" lip depth.

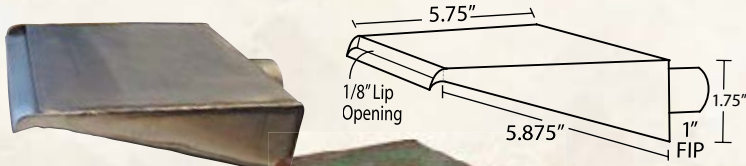

Stainless Scupper

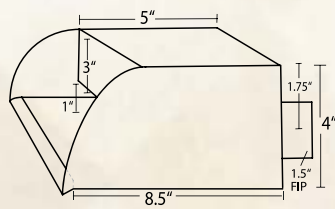

Copper Step Scupper



Metal features are available in:
 Brass Copper Stainless Steel



Finishes shown on brass. Finishes also available on copper.
 Stainless steel available in high polish.

Clearcoat Antiqued Verdigris Antique Verdigris



ABS Colors Available:

White Tan Gray

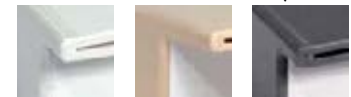



REGAL ACCENTS

Finishing Touches Of Architectural Ornaments, Fixtures and Treatments For Every Pool, Spa, Lobby or Yard.

Our estate quality accent features are frankly the easiest way to add high end luxury to an otherwise bland pool scape. Constructed of cast bronze, pre-threaded and ground ready, Regal Accents features are simple to install. These features are available in various patina finishes shown or can be left natural to allow them to develop patina on their own. Each piece is unique due to hand casting and has its own specific measurements, so contact a Custom Cascade specialist to help find the right size and style for your application.



Patinas Available clockwise:
Black, Oil Rubbed, Rust &
Verte de Gris.



Bronze Scupper
Round 5-1/2"



Bronze Scupper
Diamond 6-5/8"



Bronze Scupper
Square 6-5/8"



**Copper Fountain Spout with
Bronze Sconce**
6 1/2" Dia x 7 1/2" proj.



**Copper Fountain Spout
w/Bronze Sconce**
4 3/4" Dia. x 6 1/8" proj.



**Copper Fountain Spout
w/ Bronze Sconce 6"**



**Copper Fountain
Spout Only**
6" H x 10" proj.



**Copper Fountain
Spout Only**
10" H x 16" proj.

Visit Custom Cascade at www.oreqcorp.com and download everything you need to spec and order any of the various water features shown here. Call and place your Custom Cascade order at 800.420.3255 or to get answers to all your waterfall questions.



Custom Cascade Water Feature Style Chart

Products below may be available in ABS Plastic or Metal. Contact Customer Service for details.

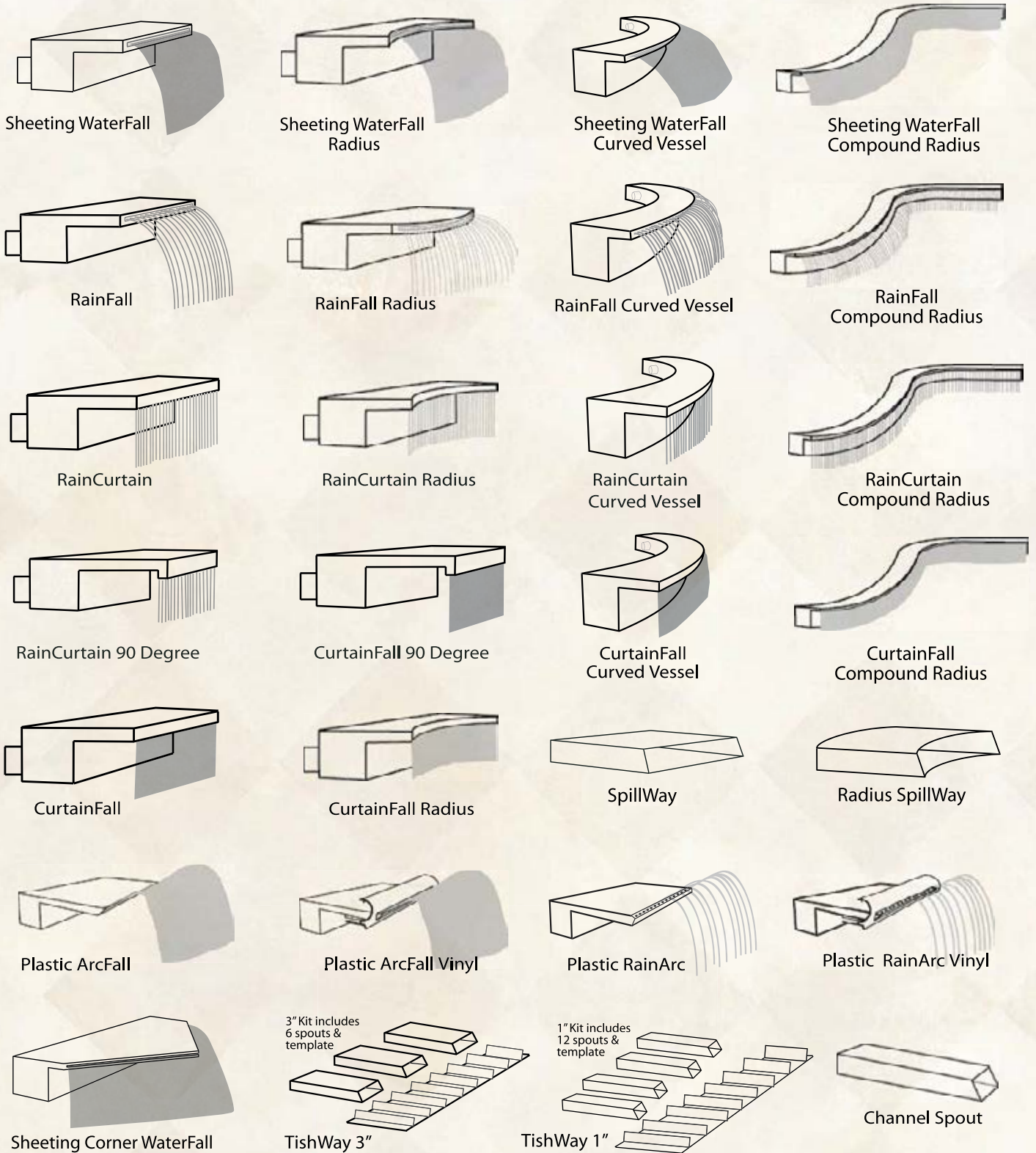

Remember this is basic information, designed to be used as a guideline only. Your specific jobs may need adjustments.

Metal features are available in:

Brass Copper Stainless Steel



Finishes shown on brass. Finishes also available on copper. Stainless steel available in high polish.

Clearcoat Antiqued Verdigris Antique Verdigris



ABS Colors Available:

White Tan Gray



Custom Cascade Water Feature Style Chart

Products below may be available in ABS Plastic or Metal. Contact Customer Service for details.

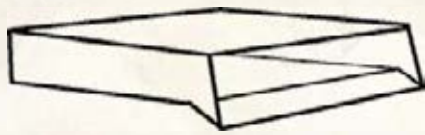

SpillWay

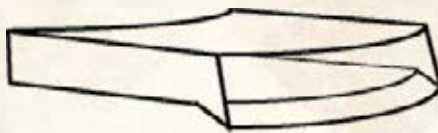

Radius SpillWay



Channel Spout

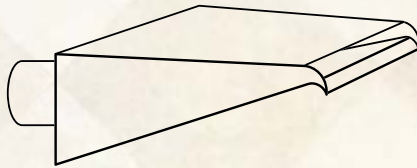

Scupper

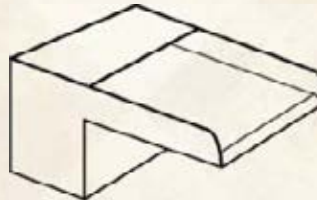

OpenTop Water Fall



Radius SpillEdge



SpillEdge



Corner SpillEdge

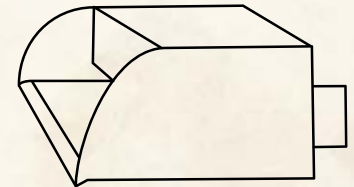

Step Scupper

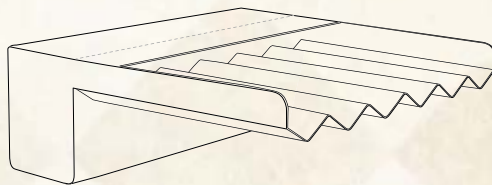

RiverFall

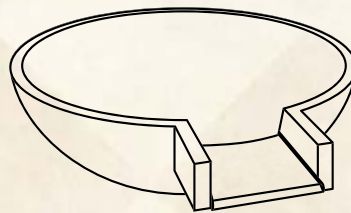

Round Travertine Urn
(Recommended SpillEdge)

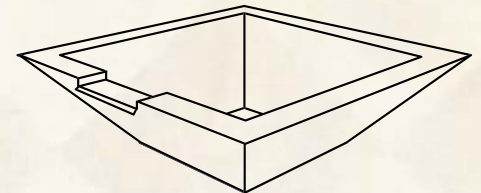

Square Pot
(Recommended SpillEdge)

Custom Cascade

A Division of Oreq Corporation
42306 Remington Ave. Temecula, CA 92590
Phone 800-420-3255 • Fax 800-434-7660
www.oreqcorp.com



Remember this is basic information, designed to be used as a guideline only. Your specific jobs may need adjustments.

Metal features are available in:

Brass Copper Stainless Steel



Finishes shown on brass. Finishes also available on copper.

Stainless steel available in high polish.

Clearcoat Antiqued Verdigris Antique Verdigris



ABS Colors Available:

White Tan Gray



EXPERIENCE THE ELEMENTS

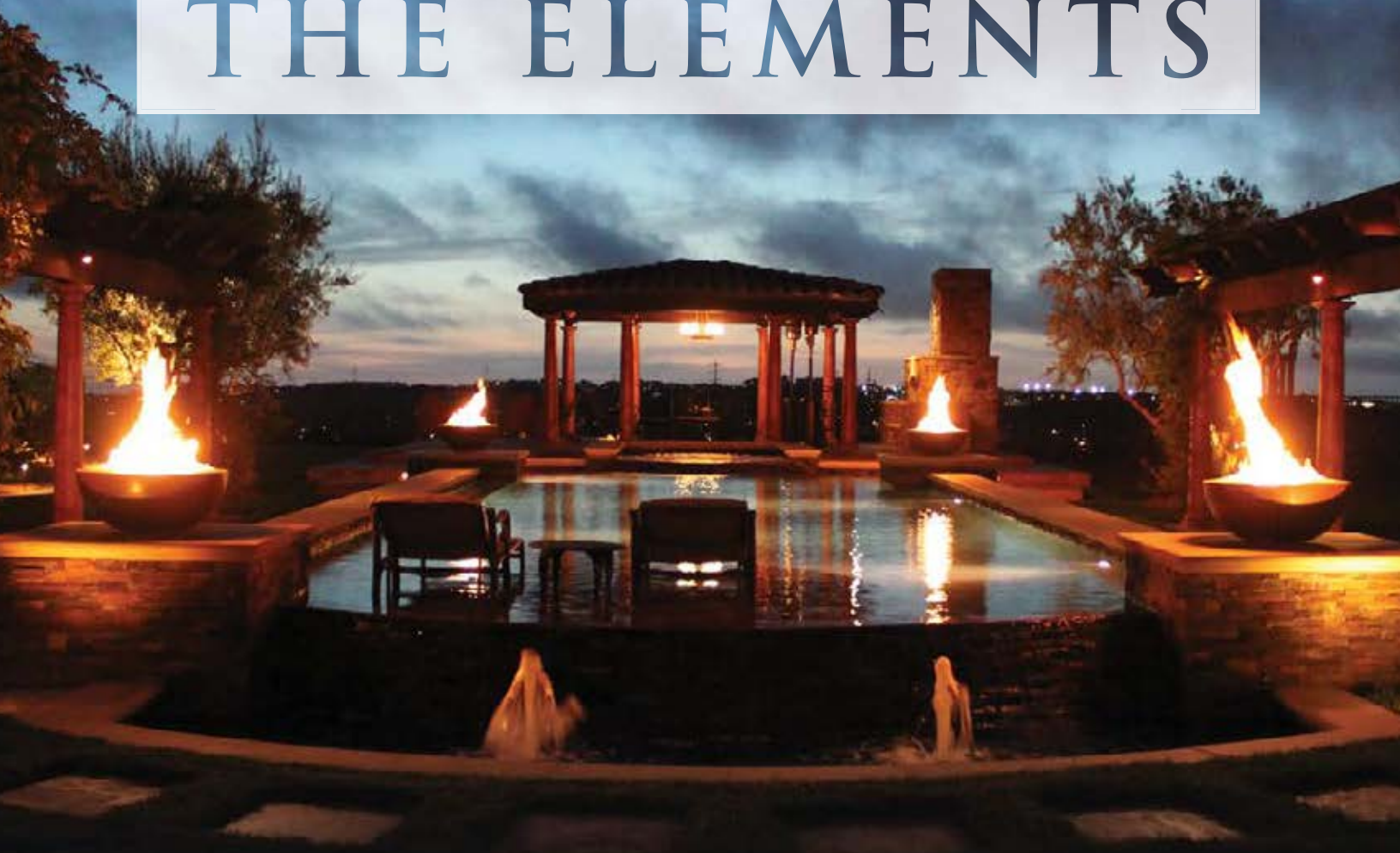

Custom Cascade's™ staff of experts have been delivering innovative and quality water features for our customers for over 25 years. Now we are introducing a whole new experience with Custom Cascade™ Fire Designs! We've integrated the element of fire with our water features; taking your waterscapes to new levels and delivering elemental experiences like never before.



Custom Cascade™
fire designs

EXPERIENCE THE ELEMENTS LIKE NEVER BEFORE