

PLAYOFF 48" SOCCER TABLE - NG1031F

Spec Sheet

UPC Code: 672875902866

End Panels are matte black laminate, 1/8" MDF front, 3/8" MDF top and 1/2" MDF structure w/ groove for playfield. Inside and edges of goal box should be black w/ min. opening of 5.5" x 2" for ball return.

Inside play area dimensions:
40" x 22.75" x 4.25"



Leg Panels are 4-color graphic on gloss black 1/8" MDF with curved bottom.

Side Panels are 4-color graphic wrapped 2-sides, 1/2" MDF with curved top edge of matte black laminate and grooved for playfield.

Legs are 3" x 3" x 31" H 1/2" MDF w/ matte black laminate.

Leg Levelers will be added to new models.

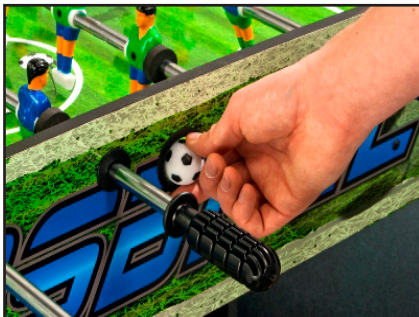

< Player detail

1/2" chrome plated steel rods to be pre-assembled with players and foam bumpers. All assembled rods are to be individually foam wrapped for protection and boxed together.



Quality 4" ABS plastic players, 13 per team, with grooved flippers for ball control, and ABS plastic easy grip ergonomic handles

Two 23" x 1.25" x 1/2" MDF bottom supports. All structural components to be CARB certified MDF.

PLAYOFF 48" SOCCER TABLE - NG1031F

Spec Sheet

Player Positions

(measurements from center of player and ends of rods, NOT including handles or end caps)

3 Player Rods (A, C, F & H): Starting from handle end of rod, 12.75", 6.75", 6.75", 10" = 36.25"*

2 Player Rods (B & G): Starting from handle end of rod, 16.25", 10", 13.5" = 39.75"*

5 Player Rods (D & E): Starting from handle end of rod, 10.5", 3.875", 3.875", 3.875", 3.875", 8" = 34"*

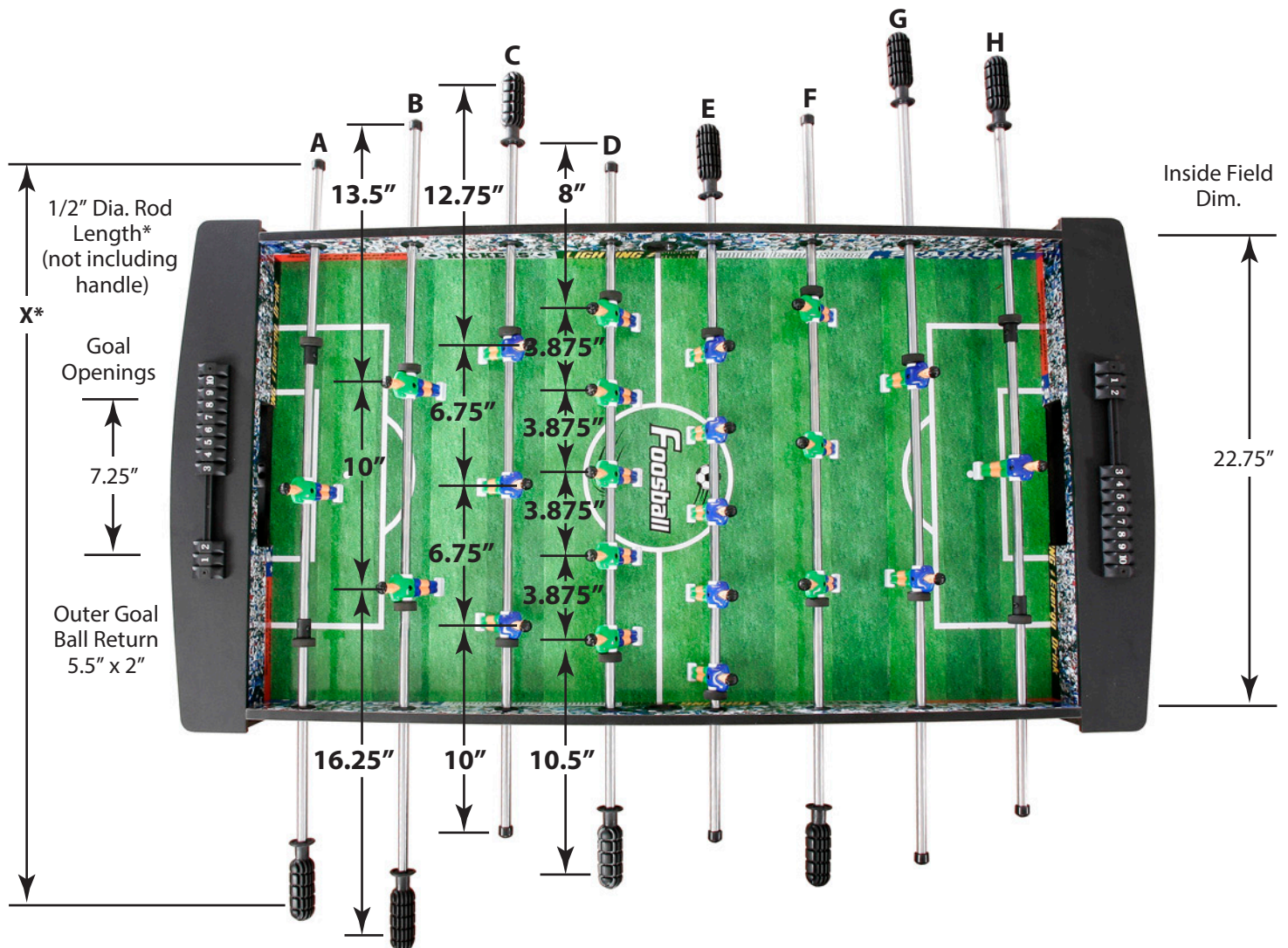

* Rod length varies depending on player count, **3-Player Rod: 36.25"**; **2-Player Rod: 39.75"**; **5-Player Rod: 34"**
Also, VERY IMPORTANT, rod ends, without handles or end caps, should NOT have sharp edges.

PLAYOFF 48" SOCCER TABLE - NG1031F



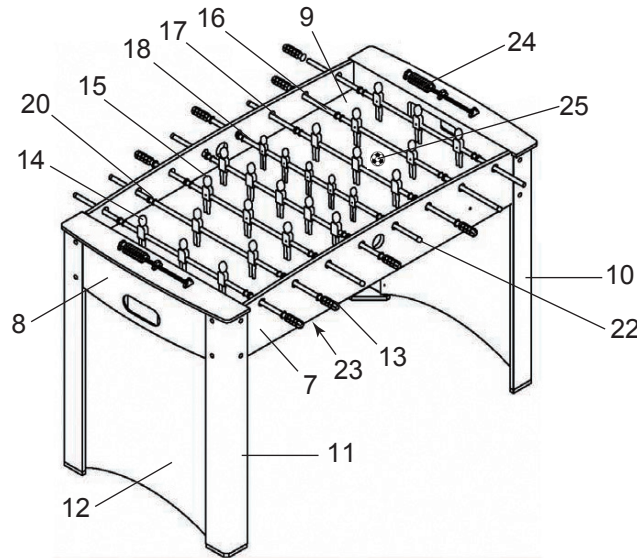



Spec Sheet

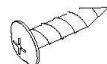

PARTS

#7 NGP5501 40" x 7.5" 1/2" MDF  x2 SIDE PANEL	#8 NGP5502 25.25" x 4" x 7" 1/8", 3/8", 1/2" MDF  x2 END PANEL	#9 NGP5503 40.5" x 23.25" 1/8" MDF  x1 PLAYFIELD	#10 NGP5504 31" x 3" x 3" 1/2" MDF  x2 LEFT LEG	#11 NGP5505 31" x 3" x 3" 1/2" MDF  x2 RIGHT LEG	#12 NGP5506 21" x 23.75" 1/8" MDF  x2 LEG PANEL	#13 NGP5507 1.125" Dia. x 3.75" Rubber  x8 HAND GRIP
#14 NGP5508 .75" x 1.25" x 4" ABS Plastic  x13 BLUE PLAYER*	#15 NGP5509 .75" x 1.25" x 4" ABS Plastic  x13 GREEN PLAYER*	#16 NGP5510 1/2" Chrome-Plated Steel Rod - 39.75"  x2 2 PLAYER ROD*	#17 NGP5511 1/2" Chrome-Plated Steel Rod - 36.25"  x4 3 PLAYER ROD*	#18 NGP5512 1/2" Chrome-Plated Steel Rod - 34"  x2 5 PLAYER ROD*	#20 NGP5513 1.125" Dia. x .375" Grey Foam  x16 FOAM BUMPER*	#22 NGP5514 .75" Dia. x .625" Rubber  x8 ROD END CAP
#23 NGP5515 23" x 1.25" 1/2" MDF  x2 SUPPORT BRACE	#24 NGP5516 10.5" x 1.5" x .625" ABS Plastic  x2 MANUAL SCORER	#25 NG5102 1.25" Dia. White Resin  x2 SOCCER BALL	* Note: Items #14 - #20 come pre-assembled as sets as part no. NGP5943 All dimensions given are approx. and represent the size at the widest point of that dimension.			

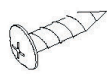
HARDWARE PACK - NGP5500 (sealed in individual numbered poly bags and then bagged as set)

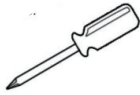
#1 x16  x16 BOLT	#2 x16  x16 FLAT WASHER	#3 x4  x4 1-1/2" SCREW	#4 x12  x12 1/2" SCREW	#5 x12  x12 1-1/2" FLAT SCREW	#6 x1  x1 HEX WRENCH	#19 x26  x26 3/4" SCREW
#21 x16  x16 PLASTIC ROD WASHER	ADDITIONAL EQUIPMENT REQUIRED:  x1 PHILLIPS HEAD SCREWDRIVER					